

Sentinel

Owner's Manual



Unitec

443-561-1200 • www.StartwithUntiec.com



SENTINEL OWNER'S MANUAL

This manual describes the functions of the Sentinel entry system running the Sierra software platform. If further assistance is needed, please contact the distributor from which the Sentinel was purchased.

When calling for assistance, you must have the following information available:

Sentinel Serial Number: _____

Distributor Name: _____

DECLARATION OF COMPLIANCE

This equipment has been tested and found to comply with the limits for a Class A digital device, pursuant to Part 15 of the FCC Rules. These limits are designed to provide reasonable protection against harmful interference when the equipment is operated in a commercial environment. This equipment generates, uses, and can radiate radio frequency energy and, if not installed and used in accordance with the instruction manual, may cause harmful interference to radio communications. Operation of this equipment in a residential area is likely to cause harmful interference in which case the user will be required to correct the interference at his own expense.

COPYRIGHT

© 2014 Unitec, Incorporated. All rights reserved. No part of this book, including text, screen examples, diagrams, or icons, may be reproduced or transmitted in any form, by any means (electronic, photocopying, recording, or otherwise) without prior written permission of Unitec, Incorporated.

TRADEMARKS

Sentinel, Unitec, and the Unitec Logo are trademarks, service marks, or registered trademarks of Unitec, Incorporated.

All other products, services, and company names are trademarks or registered trademarks of their respective owners.

Document Revision History			
Software Version	Rev	Release Date	Changes Made
1.53 Sentinel 1.73 Sierra		9/2014	Changed OS from Windows NT to Windows 7 POS Ready. Added support for card redemption for discounts, added accounting report for console printer, added support for barcode redemption for fleet and prepaid accounts, added Site Lynx code service, added batch management functions for credit modems, added multi-site account (shared payment) features, added POS code interface in external server mode, added automatic reboots to device profiles, and added prize promos to promotions.
1.43 Sentinel 1.63 Sierra		1/2014	Added following credit processors: Priority Payment Systems, Tran- Heartland (for 7-11), XML Credit (for Verifone), changed "Internet" credit to Mercury, and changed "Dial-up" to Tran. Added password security. Added code expiration of 00 to ensure codes don't expire. Added Account Transaction Report. Removed Price and Discount Columns from Fleet Report. Added date range to Summary page.
1.31 Sentinel 1.52 Sierra		12/2012	Added Dresser Wayne interface, Loyalty accounts, Account Listing Report, added ability to add taxes to credit sales, added hidden wash for fleet customers, added ability to drop more than one type of token, and revised the Site Revenue report.
1.22 Sentinel 1.42 Sierra		1/2012	Added Remote POS4000 support, Enhanced Added Services, Multi-Wash Sales, Account Reloading, Canadian Currency support, Operations Screen themes, Fleet reports, Console/Sales Screen Enhancements, Daylight Savings Time support, and Credit Modem diagnostics.
1.12 Sentinel 1.34 Sierra		6/2011	Added new reporting information.
1.02		6/2010	Initial Release



[THIS PAGE INTENTIONALLY LEFT BLANK]

Table of Contents

1	Introduction	1
2	Log-In	1
3	Set-up Functions.....	5
3.1	General Site Information	5
3.2	Product Programming.....	5
3.3	Sentinel Programming	5
3.3.1	General Information	5
3.3.2	Operating Schedule.....	6
3.3.3	Wash Dispensing.....	6
3.3.4	Added Services Dispensing	6
3.3.5	Wash Interface.....	6
3.3.6	Programming Hardware Devices	6
3.3.7	User Interface Set-up.....	7
3.4	User Management	7
3.5	POS Interface	8
3.6	Sales Screen	8
4	Promotions.....	9
4.1	Discounts.....	9
4.2	Complimentary Washes.....	9
4.3	Fundraisers.....	10
4.4	Scheduled Specials.....	10
4.5	Prize Promos	10
4.6	Promotions Setup	11
4.6.1	Prize Promo Setup.....	12
4.6.2	Promotions Setup	14
4.7	Promotions Reports	15
5	House Accounts	16
5.1	Prepaid Accounts	16
5.2	Subscription Accounts.....	17
5.3	Loyalty Accounts	17
5.4	Fleet Accounts.....	18
5.5	Account Programs.....	18
5.5.1	Pre-Paid Account Program Setup	19
5.5.2	Subscription Account Program Setup.....	20

5.6	Accounts.....	21
5.6.1	Prepaid and Subscription Accounts	21
5.6.2	Loyalty Accounts	22
5.6.3	Fleet Accounts.....	23
5.7	Account Reports.....	25
5.7.1	Status Report	25
5.7.2	Listing Report	26
5.7.3	Loyalty Report.....	27
5.7.4	Fleet Report	27
5.7.5	Sales Report	30
5.7.6	Account Transaction Report	31
6	Reports.....	32
6.1	Site Revenue Report	33
6.2	Sales Report	35
6.2.1	Cash Report.....	37
6.2.2	Transaction Report.....	38
6.2.3	Code Listing Report.....	40
7	Sales.....	41
8	Maintenance Functions	47
8.1	Cash Functions	48
8.2	Shutdown	50
9	Utilities.....	51
9.1.1	Enable Support Mode	52
9.2	Database Management.....	53
9.2.1	Compact and Cleanup Database	53
9.2.2	Delete Old Codes	54
9.2.3	Automatic Backups Schedule for Server.....	54
9.2.4	Restore Factory Defaults.....	55
10	Component Operation and Maintenance	56
10.1	Component Layout.....	56
10.1.1	Sentinel Doors.....	56
10.1.2	Inside the Sentinel	59
10.1.3	System Cabling.....	62
10.2	Cleaning and General Maintenance.....	62
10.3	Bill Dispensers (Optional).....	62
10.4	Bill Validator	62

10.5	Card Reader	69
10.5.1	Cleaning the Card Reader	69
10.6	Coin Acceptor	69
10.6.1	Coin Acceptor Cleaning and Maintenance.....	69
10.6.2	Programming the IDX to Accept \$1 Coins.....	71
10.6.3	Programming the IDX to Accept Quarters	71
10.6.4	Site-Specific Tokens	71
10.6.5	Erasing IDX Programming	72
10.7	Coin Hopper(s) (Optional)	72
10.7.1	Removing the Hopper Tray	72
10.7.2	Changing the Dispense Value.....	73
10.8	Proximity Sensor.....	75
10.9	Thermal Printer	77
10.9.1	Replacing the Printer Paper	78
10.9.2	Clearing a Paper Jam	78
10.9.3	Manually Printing a Self Test	78
Appendix A : Talaris Dual Cassette Bill Dispenser Maintenance		79

Table of Figures

Figure 1. Sierra Login Screen.....	2
Figure 2. Password Change Screen	3
Figure 3. Site Summary Screen	4
Figure 4. Promotions - Main Screen	9
Figure 5. Promotions Main Screen.....	11
Figure 6. Prize Discount Setup Screen	12
Figure 7. Prize Voucher Setup Screen.....	13
Figure 8. Edit Discount Screen	14
Figure 9. Promotions Washes	14
Figure 10. Sample Promotions Status Report.....	15
Figure 11. Sample Promotions Usage Report.....	16
Figure 12. Account Program Screen	19
Figure 13. Pre-paid Account Program Edit Screen.....	19
Figure 14. Subscription Account Program Edit Screen	20
Figure 15. Prepaid Account Edit Screen.....	22
Figure 16. Loyalty Account Setup Screen.....	23
Figure 17. Edit Fleet Account	24
Figure 18. Edit Account User.....	25
Figure 19. Sample House Account Status Report	26
Figure 20. Sample Account Loyalty Report.....	27
Figure 21. Sample House Account Fleet Report	28
Figure 96. Account Sales Report	30
Figure 23. Account Transaction Report	31
Figure 24. Sample Site Revenue Report.....	34
Figure 25. Sample Sales Report	35
Figure 26. Sample Cash Report	37
Figure 27. Sample Transaction Report.....	39
Figure 28. Sample Transaction Details.....	39
Figure 29. Sample Code Listing Report	40
Figure 30. Sales Screen	41
Figure 31. Purchase Wash Package Screen.....	42
Figure 32. Wash Purchased Screen.....	42
Figure 33. Account Purchase.....	43
Figure 34. Reload Account Screen	44
Figure 35. Reloaded Account Screen	44

Figure 36. Rewash Selection Screen	45
Figure 37. Rewash Code Issued Screen.....	45
Figure 38. Report Date Selection Screen	46
Figure 39. Sentinel Maintenance Screen	47
Figure 40. Cash Deposit Screen.....	48
Figure 41. Cash Removal Screen.....	49
Figure 42. Shutdown Screen	50
Figure 43. System Utilities Screen.....	51
Figure 44. Enable Support Mode Screen	52
Figure 45. Database Utility Screen.....	53
Figure 46. Database Compact and Clean Screen	53
Figure 47. Delete Old Codes Screen.....	54
Figure 48. Automatic Backup Settings Screen	54
Figure 49. Sentinel Front View Visible Components.....	57
Figure 50. Sentinel Door – Left Interior	58
Figure 51. Sentinel Door – Right Interior	59
Figure 52. Electronic Components Inside the Sentinel Case (Left Side)	60
Figure 53. Components Inside the Cash Vault (Right Side)	61
Figure 54. Mars Bill Validator/Stacker	63
Figure 55. Mars Bill Validator—Top View	63
Figure 56. Mars Bill Stacker Replacement	64
Figure 57. Mars Flash Code LED.....	65
Figure 58. Mars with Lower Housing	67
Figure 59. Mars with Lower Housing Removed	67
Figure 60. Mars DIP Switches.....	68
Figure 61. Outside/ Inside of the IDX.....	70
Figure 62. Hopper View - Removing the Hopper - Cube Top	73
Figure 63. Hopper View - Top Removed	74
Figure 64. Dispensing Wheel Removed	74
Figure 65. Guide Arm Cover Removed.....	75
Figure 66. Hecon Printer	77
Figure 67. Bill Dispenser Parts	79
Figure 68. Remove the Bill Cassette	80
Figure 69. Unlock Cassette.....	80
Figure 70. Load Bills into Cassette	82
Figure 71. Tension Plate and Lid	83
Figure 72. Insert Cassette	84
Figure 73. Remove Reject Vault.....	85
Figure 74. Unlock and Open Reject Vault	86
Figure 75. Insert Reject Vault.....	87



Figure 76. Release Back Flaps 88
Figure 77. Clear the Back Flaps 88
Figure 78. Unlock the Top Lid 89
Figure 79. Clear the Bill Path..... 90



1 Introduction

The Sentinel is touch-screen based car wash payment system that is designed to work at any in-bay automatic or conveyor and is perfect for the express exterior car wash. This Owner's Manual describes the programming features and provides information on daily operations and recommended maintenance.

For detailed information on how to install the Sentinel and for networking information, please see the *Sentinel Installation Manual*. For detailed information on how to program the Sentinel, please see the *Sierra Management Application Operations Manual*. All of these manuals are available on the manufacturer's website:

www.StartwithUnitec.com

2 Log-In

A PC with a standard Internet browser is required to access the Sierra Management Application. The PC can be located either on-site or off-site. The entry system unit's Installation Manual provides guidelines for connecting a PC to the local site network.

To access the management application, type the following into the address bar:

<http://XXX.XXX.XXX.XXX:9810/web> (where XXX equals your site IP address).

When a connection to the server is established, the login page should appear (as shown below). At initial startup, you will use the Owner user account (user ID 00, password 00).

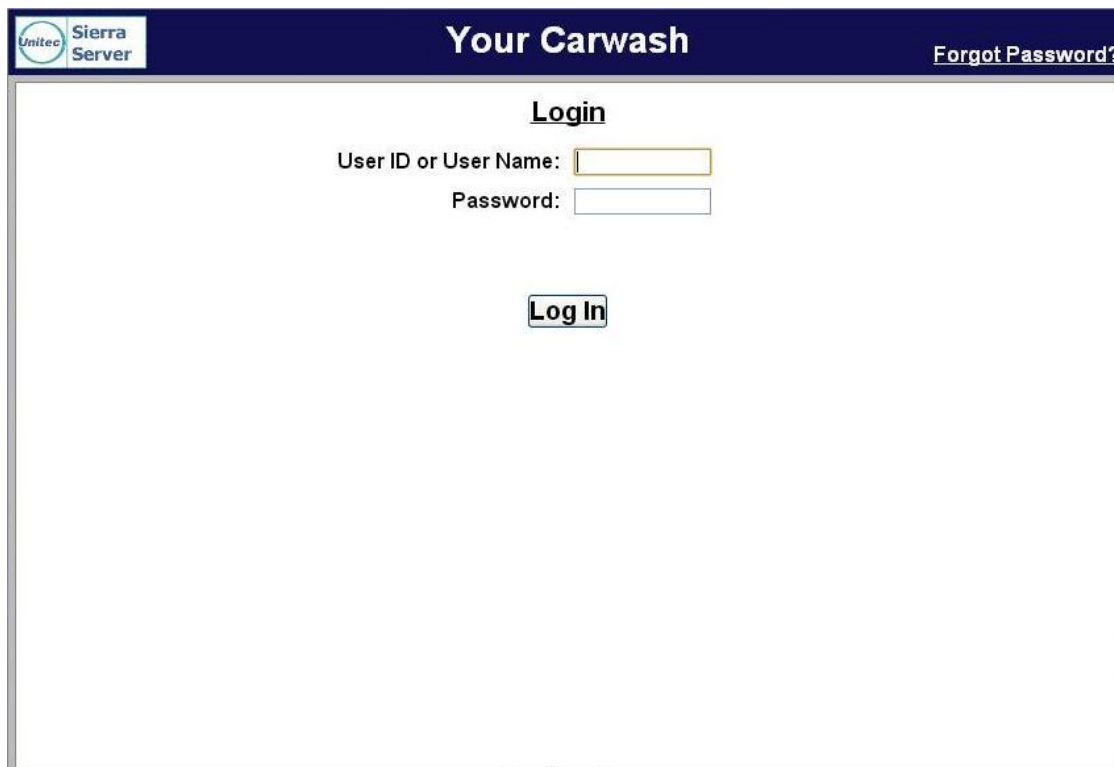

The screenshot shows a web browser window with a dark blue header. On the left of the header is the Unitec Sierra Server logo. In the center of the header is the text "Your Carwash". On the right of the header is a link that says "Forgot Password?". Below the header is a white login form. At the top of the form is the word "Login" in bold. Below that are two input fields: "User ID or User Name:" followed by a text box, and "Password:" followed by a text box. At the bottom of the form is a button labeled "Log In".

Figure 1. Sierra Login Screen

Due to PCI compliance, once you login the first time using an administrative password, you will immediately be prompted to change your password to a more secure password that is at least 7 characters long and contains both letters and numbers, as shown below.

NOTE: An administrative password is a user that has either "User Management" or "Utilities" access privileges under Setup>Users.

NOTE: To setup a non-administrative user to verify and sell codes or sell accounts, "Accounts and Promotions" and "Code and Account Sales" must be checked on the user account.

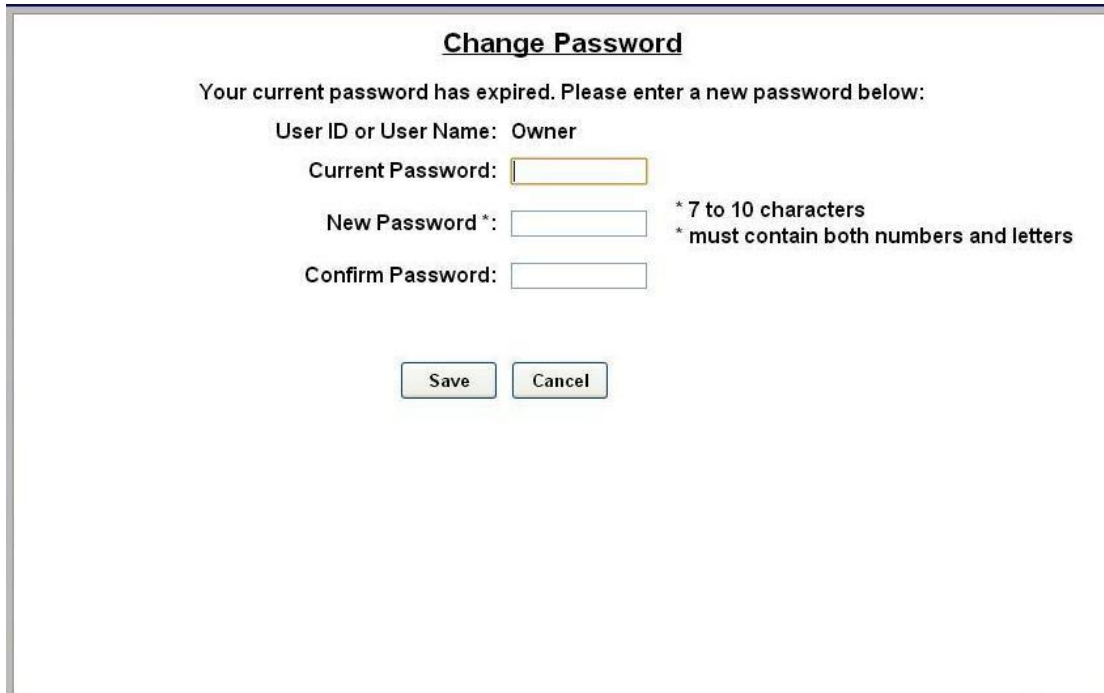

Change Password

Your current password has expired. Please enter a new password below:

User ID or User Name: Owner

Current Password:

New Password *: * 7 to 10 characters
* must contain both numbers and letters

Confirm Password:

Figure 2. Password Change Screen

To change the password, enter your old password, then enter your new password. Enter your new password again, then click Save.

You will be required to create a new password every 3 months. Please make note of the password and keep it in a secure location. You may not use the last 5 passwords.

After setting up your password, you may login to Sierra normally. If you forget your password, you may click on the Forgot Password? link on the top right of the login page (see Figure 1). Your password will be emailed to you. Please note that your email address must have been entered into the User profile in order for the password to be emailed to you. For more information, please see Section 3.5.

NOTE: If you enter your password incorrectly 6 times, you will be locked out of the system for half an hour.

NOTE: The new password will also be required to login to the Maintenance screens on the Portal, Sentinel and C-Start units. A keyboard will appear at units that have a touchscreen. For Portals that have a keypad, you either must use a keyboard to login, or you must scroll through the keys on the side of the display to enter your password.

Upon successful log-in, the Summary page of the management application will appear. This page displays a list of Sentinels present on the local network with a count of washes provided and associated revenue for the current day. Car counts and revenue results from previous days can be viewed by selecting the desired date in the calendar or by entering a date range in the summary data fields. The current day data can be updated by selecting the Refresh button. The management functions are shown across the top of the page. As each function is selected, a secondary menu of related options will appear on the left hand side of the page.

Summary
Reports
Accounts
Promotions
Setup
Sales
Utilities

Site Summary

Current Date: 10/1/13 (Tuesday)
Current Time: 10:39:12 AM

Summary Data for:

Start Date: End Date:

< October 2013 >						
Sun	Mon	Tue	Wed	Thu	Fri	Sat
23	24	25	26	27	28	1
2	3	4	5	6	7	8
9	10	11	12	13	14	15
16	17	18	19	20	21	22
23	24	25	26	27	28	29
30	31	1	2	3	4	5

Device	Status	Count	Cash	Credit	Pre-Paid	Fleet	Total	Details
Bay 1	Idle	0	\$0.00	\$0.00	\$0.00	\$0.00	\$0.00	<input type="button" value="Details..."/>
Bay 2	Idle	0	\$0.00	\$0.00	\$0.00	\$0.00	\$0.00	<input type="button" value="Details..."/>
Totals		0	\$0.00	\$0.00	\$0.00	\$0.00	\$0.00	

Figure 3. Site Summary Screen

3 Set-up Functions

The Set-up function are used to program the Sentinel's operational settings and for managing system users. Sentinel programming should be performed during installation by your Unitec distributor, but there are some settings that an equipment owner may wish to change, periodically. This section of the manual describes the programmable features that are available. For specific details on using these features, see the *Sierra Management Application Programming Manual* on the manufacturer's website: www.StartwithUnitec.com.

3.1 General Site Information

Site information should be set during installation and would not typically need to be changed. The programmable features under site information include the site name and ID (as shown on reports and notifications), accounting close time, and credit card account set-up.

3.2 Product Programming

Products are Wash Packages or Added Services that can be purchased by a customer. The products will need to be set up by the installing distributor, but the equipment owner may need to access this feature to change prices or change the Added Services that will be offered with the wash packages.

3.3 Sentinel Programming

The Sentinel's is configured by creating a 'device profile' and downloading the profile to the Sentinel. Whenever a change is made to the device profile, the associated devices will need to be downloaded with the revised profile to implement the changes. The device profile configuration file includes a series of set-up pages, which are described in the following sections.

3.3.1 General Information

The Edit Profile Information page is used to program some general operational settings of the Sentinel including:

- Offline Mode – When 2 or more Sentinels are installed at a site, one will serve as a Master unit while the others will be secondary units. If the Master unit becomes inoperable, the secondary units will go to an off-line state. The Sentinel can be configured so a secondary unit will go 'out of service' if off line or operate in a 'cash only' mode (the default).
- Exact Change Mode – When enabled (the default setting), the Sentinel will display 'Exact Change Only' when it detects that the change dispensers are empty or have failed.
- Upgrades – When upgrades are enabled, a customer using a prepaid wash code or account will be offered to upgrade to a better wash by adding more payment. Upgrades are disabled by default,

but can be enabled for wash codes (bought at the pump or in the C-store), pre-paid house accounts and/or, subscription house accounts.

3.3.2 Operating Schedule

The Operating schedule allows you to automatically set an opening and closing time for your car wash. The message that is displayed when the site is closed can be programmed on the User Interface Set-up Page (described in section 3.3.7). Operating schedules can be configured to vary by day of the week. The operating schedule is disabled by default.

3.3.3 Wash Dispensing

The wash dispensing page is used to assign and configure the wash packages that will be offered at the Sentinel. Wash packages must be set-up through the Products page (section 3.2) before they can be assigned to a Sentinel device profile. This feature will typically not be changed after installation, but there are some features of a wash package that an owner may want to adjust including:

- Added Services Offered – Allows one or more additional services to be offered to the purchaser of the wash package. The Added Services to be offered can vary by package. An added service must be added to the device profile (per section 3.3.4) before it can be assigned to a wash package.
- Token Dispensing – When enabled, one or more tokens will be dispensed with each purchase (of the wash package).
- Wash Details Text – The wash details text is displayed under the Wash name inside the wash selection button. Up to 7 lines of text (18 characters per line) can be added. The wash selection button will be sized to fit the amount of text entered so the buttons can be made larger by entering more lines of text.

3.3.4 Added Services Dispensing

The Added Services Dispensing page is used to select and configure the added services that will be offered with one or more of the wash packages. Added services must be set-up through the Products page (section 3.2) before they can be assigned to a Sentinel device profile. An added service can be configured to dispense one or more tokens when purchased. This feature allows an operator to sell token packages as an added option to the wash purchase.

3.3.5 Wash Interface

The Wash Interface Set-up page is used to configure the hardware interface between the Sentinel and the wash controller. These settings should only be changed by your distributor.

3.3.6 Programming Hardware Devices

The Peripherals page is used to configure the various hardware devices in the Sentinel such as cash acceptors and dispensers. These settings would typically not be changed after installation.

3.3.7 User Interface Set-up

The User Interface set-up page is used to change messages displayed to customers and adjust 'time-out' values for certain user screens. There are several features on this page that an operator may wish to adjust including:

- Greeting Message Delay – The delay from when a vehicle is detected (at the Sentinel) until the greeting message is played.
- Added Services Screen Timeout – The amount of time the Added Services offer screen will be shown. If no selection is made within this time, the Sentinel will assume no added services are desired and transition to the next screen.
- Wash Options Screen timeout and text – Wash options are enabled (through the Wash Dispensing page) to ask the consumer to select one of 2 options after their wash purchase. A typical use of this feature is to ask the customer of a hybrid wash to choose either 'touchless or Soft Touch'. The screen timeout allows the Sentinel to move to the next screen if the customer does not make their selection within the allotted amount of time set by the timeout value.
- Force Receipt – When enabled, a receipt will automatically be provided to each customer. When disabled, customers will be prompted for a receipt and one will be provided if they press the receipt button.
- Banner Text – Not applicable to the Sentinel.
- Wash Closed Text – The message that is displayed when the Sentinel closes, as programmed by the Out of Service schedule.
- Post Sale Text – A programmable message that will be displayed after a customer's purchase if the wash is busy.
- Receipt Text – Used to program up to 3 lines of text in the receipt header and 7 lines in the receipt footer.

3.4 User Management

Unique User IDs and passwords should be set up for employees, service personnel or others that may need access to the Sentinel. The User Set-up pages are used to create new user accounts and to edit or delete an existing account. User privileges that can be assigned are arranged in groups as follows:

- User Management – Allows the user to set-up and manage other user accounts.
- Device Access – Allows a user to open the Sentinel (without activating the alarm) and accessing the maintenance mode of the Sentinel.
- Device Set Up – Allows access to the device (profile) programming functions.

- Cash Adjustments – Allows the user to access the cash deposit and removal functions in Maintenance mode. These functions are used to adjust calculated cash balances as change is restocked or cash is removed from the Sentinel.
- Accounts and Promotions – Allows the user to set up and manage promotional programs and house accounts.
- Code and Account Sales – Allows the user to Access the optional console pages (for prepaid wash code sales).
- Reports – Allows the user to access the Sentinel’s accounting reports
- Utilities – Allows the user to access system utilities including data logging and database back-up functions.

NOTE: An administrative password is a user that has either “User Management” or “Utilities” access privileges under Setup>Users.

NOTE: To setup a non-administrative user to verify and sell codes or sell accounts, “Accounts and Promotions” and “Code and Account Sales” must be checked on the user account.

3.5 POS Interface

The POS Interface function is used to configure the interface to a Point of Sale register in use at a C-store. These settings would typically not be changed after installation and should only be changed by your Unitec distributor.

3.6 Sales Screen

The Sales screen set-up is used to configure the user buttons screen of the console screen. A button can be configured to issue a code for a specific wash package, check status of a code, or void a previously issued code. Buttons can also be used to print revenue or sales reports if a report printer is connected to the optional print server.

4 Promotions

The promotions feature is used to set up and manage various marketing programs. The types of programs that are available include discounts, complimentary washes, fundraisers, scheduled specials and prize promotions. Reports for tracking and managing these programs are accessed through the menu options on the left side of the promotions management pages (as shown below). The value of promotions used in a time period is shown in the 'discounts' field of the summary section at the top of the site revenue report.

NOTE: Coupons are not supported for Canadian sites.

Summary	Promotions				
Status Report					
Usage Report					
	Name	Type	Status	Edit	Delete
	\$ off coupon	Discount	Active	Edit...	Delete
	\$1 Token	Discount	Active	Edit...	Delete
	Boy Scouts	Fundraiser	Active	Edit...	Delete
	Grand Opening	Free Wash	Active	Edit...	Delete
	Promotion Type: <SELECT> <input type="button" value="Add New Promotion..."/>				

Figure 4. Promotions - Main Screen

4.1 Discounts

Discounts can be configured so the value varies by wash package. The methods for redeeming a discount include code entry, card, coupon (inserted at the Bill Acceptor) or token. Other programmable features include:

- Usage Limit – total number of uses allowed and number of uses allowed in a single transaction
- Scheduling – Limit use of the discount to a specific date range, specific days of the week and/or, specific hours of the day

4.2 Complimentary Washes

The complimentary wash promotion provides a free wash when redeemed. Like the discount, this promotion can be configured for redemption by a code, paper coupon or token. The complimentary wash can also be set with a schedule to limit the days and/or hours when it can be used.

When a complimentary wash promotion is redeemed, the customer need not select a wash, as the associated wash will be automatically activated. If added services are enabled, customers will be allowed to purchase these services by adding payment.

4.3 Fundraisers

The fundraiser is a code-activated promotion intended to encourage supporters of an organization to use the car wash. No discount or other benefit is provided to the user at the wash but usage of the fundraiser 'code' is tracked and reported. The operator will typically donate a set amount to the organization for each wash purchase where the fundraiser code was entered. Fundraisers can be configured to apply to any of the available washes and usage can be controlled by a schedule and a limit for the total number of redemptions allowed.

When a fundraiser code is entered and validated, a thank you message will be displayed and washes that are not associated with the fundraiser will be removed from the product selection screen.

4.4 Scheduled Specials

Scheduled specials are discounts that are scheduled to automatically be applied at certain times and on specific days. The special can be configured to apply to any and all of the available washes and the amount of the discount can be set to vary for each wash package. When a scheduled special is active, the price posted for the associated wash will be reduced (on the wash section screen). The car wash operator can set up scheduled specials so an additional discount can, or cannot, be applied when the special is active.

4.5 Prize Promos

The prize promotion is a slot machine style promotion that allows for customers to play a game and win either discounts or vouchers. The prize promo screen is presented to the user after payment is complete but before the wash is dispensed. A maximum of three prize promotions can be configured at one time. Customer participation is optional.

- Any active prize can be awarded when the prize promo is presented (in accordance with the configured prize limits)
- The award frequency can be configured independently for each prize promo.
- Any three of a kind wins one of the (up to) three prizes.
- The redemption method is always a code printed on a receipt.

4.6 Promotions Setup

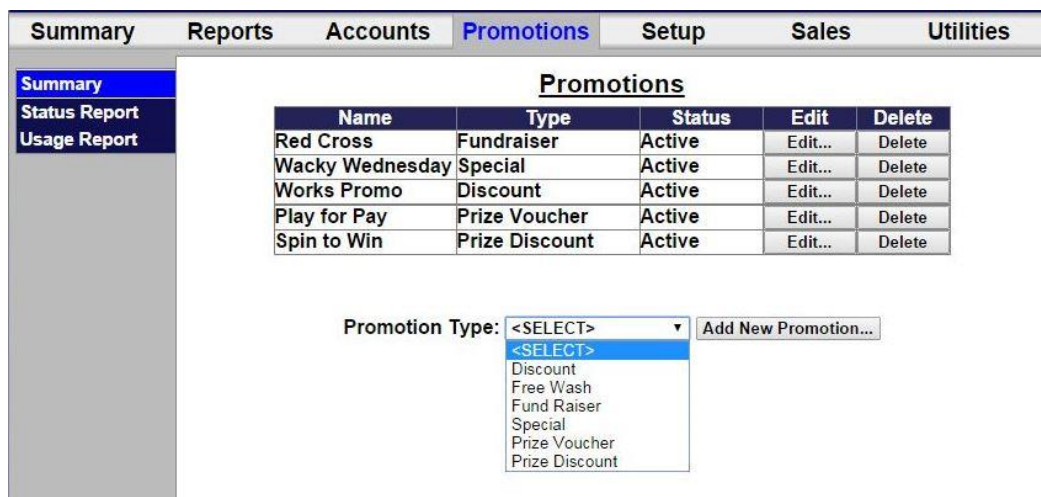

The screenshot shows the 'Promotions' tab selected in a software interface. The interface has a top navigation bar with 'Summary', 'Reports', 'Accounts', 'Promotions', 'Setup', 'Sales', and 'Utilities'. On the left, there is a sidebar with 'Summary', 'Status Report', and 'Usage Report'. The main content area is titled 'Promotions' and contains a table of active promotions. Below the table is a 'Promotion Type' dropdown menu and an 'Add New Promotion...' button.

Name	Type	Status	Edit	Delete
Red Cross	Fundraiser	Active	Edit...	Delete
Wacky Wednesday	Special	Active	Edit...	Delete
Works Promo	Discount	Active	Edit...	Delete
Play for Pay	Prize Voucher	Active	Edit...	Delete
Spin to Win	Prize Discount	Active	Edit...	Delete

Promotion Type: <SELECT> Add New Promotion...

- <SELECT>
- Discount
- Free Wash
- Fund Raiser
- Special
- Prize Voucher
- Prize Discount

Figure 5. Promotions Main Screen

The Promotions Setup screen displays the current promotions. They are listed by name, type of promotions, and status. Note that the promotion statuses are 'active', 'inactive', 'expired', and 'exhausted'. 'Expired' means beyond the promotion schedule end date/time. 'Exhausted' only applies to promotions that have a maximum usage configured.

To setup a new promotion, select the type of promotion from the drop-down menu below the table and click Add New Promotion. The Edit Discount screen will be displayed.

4.6.1 Prize Promo Setup

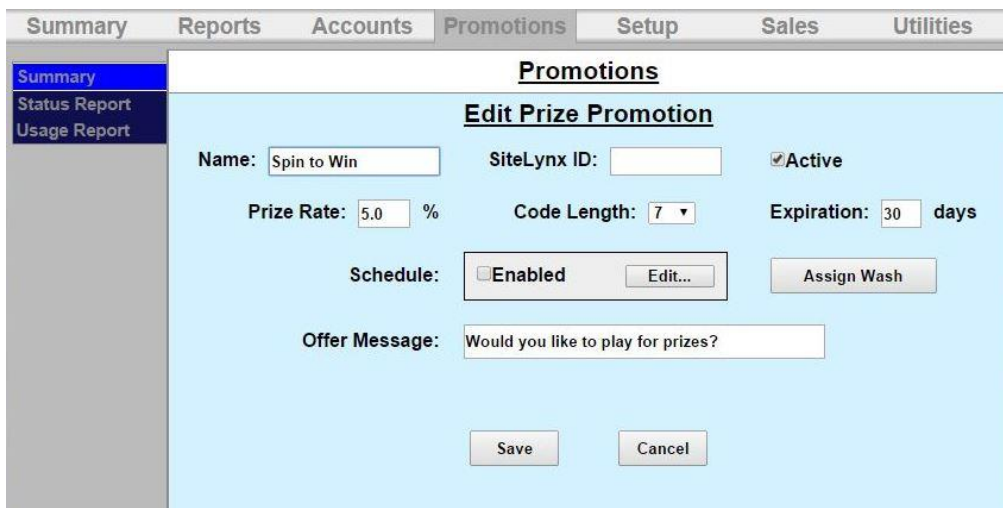

Figure 6. Prize Discount Setup Screen

1. To setup a Prize Discount, enter the name of the prize discount.
2. Enter the Prize Rate. The prize rate is the number of wins divided by the number of attempts (in percent).
3. Select a code length form 5-8. The default is 7.
4. Enter the prize expiration date. This can be set from 0-30 days. 0 days means the prize does not expire. The default is 30.
5. If you would like to enable a Schedule, click Enabled and Edit. Select the days and times the prize promo will be offered and click Save.
6. On the Assign Washes screen, a single wash can be assigned to this prize promotion along with the corresponding discount.
7. Enter the Offer Message. This field is limited to 140 characters.
8. Click Save.

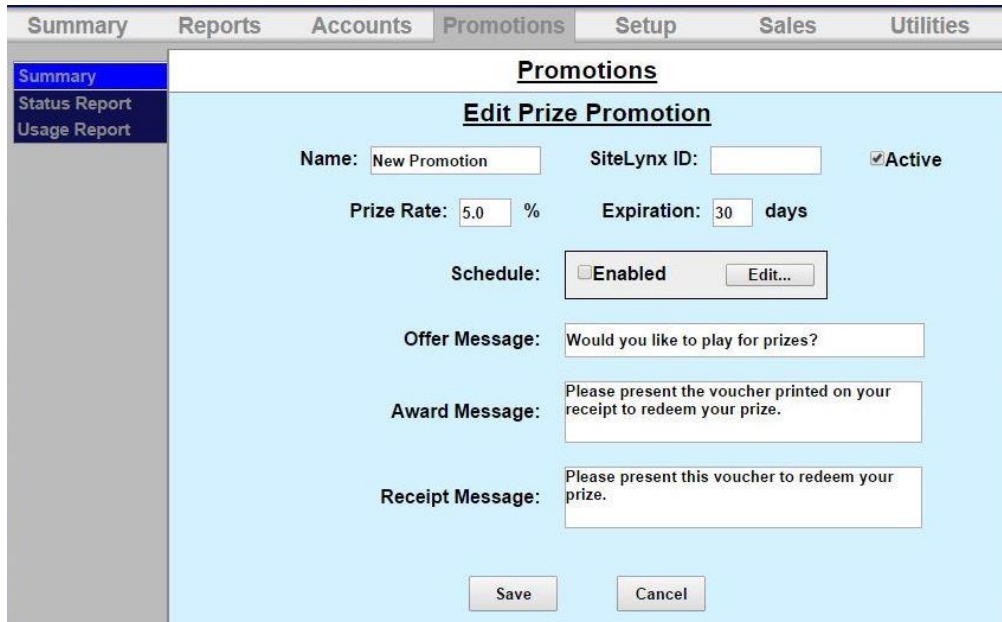

Figure 7. Prize Voucher Setup Screen

1. To setup a Prize Voucher, enter the name of the prize voucher.
2. Enter the Prize Rate. The prize rate is the number of wins divided by the number of attempts (in percent).
3. Select a code length form 5-8. The default is 7.
4. Enter the prize expiration date. This can be set from 0-30 days. 0 days means the prize does not expire. The default is 30.
5. If you would like to enable a Schedule, click Enabled and Edit. Select the days and times the prize promo will be offered and click Save.
6. Enter the Offer Message, Award Message and Receipt Message. These fields are limited to 140 characters.
7. Click Save.

4.6.2 Promotions Setup



The screenshot shows the 'Promotions' window with the 'Edit Discount' sub-window active. On the left, there is a navigation menu with 'Summary', 'Status Report', and 'Usage Report'. The main area contains the following fields and controls:

- Name:** A text input field containing '\$1 Token' and a checked 'Active' checkbox.
- Method:** A dropdown menu currently set to 'Token 1' and an unchecked 'Limit Use' checkbox.
- Schedule:** An unchecked 'Enabled' checkbox.
- Buttons: 'Assign Washes...', 'Save', and 'Cancel'.

Figure 8. Edit Discount Screen

1. Enter the Name of the promotion. Select Active to enable the promotion.
2. Select the method of the promotion from the drop-down menu. For Discounts and Free Washes, the methods are: Codes, Tokens 1-4, Cards, Barcodes and VIP Coupons 1-3 and Mars Coupon. If Mars Coupon is selected, you will need to enter the 4-digit code from the coupon. For a Fundraiser, you may only choose Codes. For a Special, there is no method to choose from.
1. If you wish to limit the use of the promotion, select Limit Use then enter the maximum number of times the promotion can be used.
2. If you want the promotion to only run on certain days, under Schedule, click Enabled. Fill out the times and days on the subsequent screen. For Specials, you MUST fill out the schedule.
3. Click Assign Washes.



The screenshot shows the 'Promotions' window with the 'Assign Washes' sub-window active. The main area contains the following fields and controls:

- Promotion:** A dropdown menu set to 'Coupon 1'.
- All Washes:** A dropdown menu set to '<SELECT>' and an 'Add to List' button.
- Applicable Washes Table:** A table with three columns: 'Applicable Washes', 'Discount', and 'Remove from List'. It contains one row for 'Deluxe Wash' with a discount of '\$ 1.00' and a 'Remove from List' button.
- Buttons: 'Save' and 'Cancel'.

Figure 9. Promotions Washes

4. Select the wash you wish to assign from the drop-down menu then click Add to List.
5. Enter the amount the discount is worth. Repeat for any additional washes the discount will be applied to.

6. Click Save. If you wish to change or delete a wash, click Remove from List by that wash.
7. Click Save.

4.7 Promotions Reports

Status Report

The status report lists all promotions that have been configured and provides status information, as shown in the sample report below. The status will be active, inactive (disabled), exhausted (max uses limit reached) or expired (end date is reached). The uses and value fields show the total number of times the promotion was applied and the associated value of discounts applied.

Promotions Status								
Site: <Insert Site Name Here>						Run Date: 9/1/2008		
Promotion Name	Status	Start Date	End Date	Type	Method	Code	Uses	Value
Wacky Wednesday	Active	3/15/2008	12/31/2008	Special			786	\$1,272.00
Gazette Promo	Active	6/25/2008	12/31/2008	Discount	Code	94852	245	\$245.00
Express Lube	Inactive	6/1/2008	12/31/2008	Free Wash	Coupon	12571	200	\$1,400.00
Boy Scouts	Exhausted	8/1/2008	11/1/2008	Fundraiser	Code	78321	100	\$100.00
Valpak Mailer	Expired	1/1/2008	2/1/2008	Discount	Code	35937	30	\$40.00

Figure 10. Sample Promotions Status Report

Usage Report

The Usage report provides a count and value of the promotions used over a user defined date range. The report will also show the percentage of washes to which the promotion was applied. The report will appear as shown below.

Promotion Usage Report					
Site: <Insert Site Name Here >			Run Date: 9/1/2008		
Report Period: mm/dd/yyyy to mm/dd/yy					
Promotion Name	Type	Wash	Count	Value	% of Sales
Wacky Wednesday	Special	Works	12	\$15.00	12.0%
Gazette Promo	Discount	Supreme	6	\$6.00	4.0%
Express Lube	Free Wash	Supreme	15	\$105.00	2.0%
Boy Scouts	Fundraiser	Works	8	\$8.00	4.0%
		Deluxe	3	\$3.00	1.0%
Valpak Mailer	Discount	Deluxe	11	\$11.00	1.0%

Figure 11. Sample Promotions Usage Report

5 House Accounts

The accounts module is a product option that allows house accounts to be set up and managed in the Sierra server application. Four account types are available: prepaid, subscription, loyalty, and fleet accounts. Accounts can be configured for redemption by a magnetic stripe card, numeric code or RFID tag. The Accounts module also includes reports for tracking account status and usage. Management functions will appear on the left side of the Accounts management page.

5.1 Prepaid Accounts

Prepaid accounts function as a gift card and can be configured with either a monetary value or a number of prepaid washes (e.g. 5 wash pass). Revenue received from the sales and recharges of prepaid accounts is shown in the *Other Revenue* section of the Site Revenue Report. Account uses (or redemptions) are reported under the *Prepaid* column in the *Net Sales* section of the Revenue Report. Once a prepaid account is set up for a customer, cards, codes, barcodes, or RFID tags may be activated and assigned to the customer.

The recommended method for issuing a prepaid account is to first create an Account Program through the *Programs* option in the Accounts menu. Example programs would be a \$50 gift card or 5 Express Wash pass. Once a program is established, individual accounts can be issued through the *Accounts* option in the Accounts menu. Configuration options for prepaid accounts include:

- Schedule – restricts the account for usage on certain days or during certain hours
- Expiration – set an expiration date for the account

- Frequency limit – set a frequency limit for account usage (e.g., once per day, 3 times per week, etc...)

You may reload the account without reentering all information, and the customer may also reload his account at the entry unit. If the balance of the account is insufficient for the purchase, the customer will be asked if they'd like to recharge the account. If they choose to do so, they'll be prompted to add payment and the account will be recharged for the amount that's defined in the account program. For instance, if the account program is configured to provide (5) \$10 washes for \$40, the customer will be charged \$40 for the reload and 5 washes will be added to their account. One of those will be applied to the current sale so the remaining balance will be 4 washes. Please note that this feature will also apply to 'multi-wash' codes.

5.2 Subscription Accounts

Subscription accounts are designed to support an 'unlimited' wash application. These accounts are product-based accounts and are valid for a specific wash package. It should be noted, however, that customers using a subscription account are able to add money to upgrade to a better wash if *Upgrades* are enabled. As Sierra does not include a recurring billing application for subscription account payment, the sale of a subscription account is not reported as revenue. Likewise, redemptions against these accounts are not reported as revenue. Redemptions are included in the *Transaction Count* in the summary section of the revenue report but are excluded from the *Paid Transactions* count.

As with prepaid accounts, subscription accounts should be set up by first creating a subscription account program (e.g. Gold, Silver, Bronze pass) than issuing individual accounts from the desired program. Subscription accounts can also be configured to operate on a schedule and have expiration dates and frequency limits.

5.3 Loyalty Accounts

Loyalty accounts provide incentives to 'members' in order to encourage repeat visits. This feature offers two different programs: member discounts and frequent shopper rewards. The discount application entitles club members to discounts on one or more wash products. The frequency application functions as an 'electronic punch card' that provides rewards for repeat customers (e.g. buy 4, get the 5th for free).

A program must be setup for both options. When configuring the options, you must configure the following information:

- Program name
- Assign washes and discount values
- Allow other discounts – indicates whether other discounts can be combined with member discounts (should be enabled by default).
- Schedule – days/hours when the member discount can be used (default is 24/7)

The configuration options for the frequency program include:

- Program Name
- Assign washes – select washes that, when purchased, qualify towards a reward
- Frequency Reward – select wash that will be awarded
- Expiration – Days in which rewards must be claimed (default will be no expiration)

Accounts will be activated from the management pages by selecting the associated loyalty program and entering the customer-specific data, including:

- User name and contact details (address, e-mail etc.)
- Account Number
- Redemption method – Code, Card or RF Tag

5.4 Fleet Accounts

Fleet accounts are intended as a ‘house credit’ application where a business will be billed for usage. Typical customers for fleet accounts include local law enforcement agencies and private businesses with a number of vehicles in their fleet. Fleet accounts are set up directly from the *Accounts* menu option and not from the *Programs* menu. Once a fleet account is set up for a business, cards, codes, barcodes, or RFID tags may be activated and assigned to individual users (or vehicles).

Fleet accounts can be set up to restrict a user to a single product or to allow them to select any available product. The feature also allows the car wash Operator to assign a discount (as a dollar value or percentage) to the account. This discount will be applied in the Account Transaction report, which serves as the fleet customer’s statement (for billing).

The fleet account set-up page also has a check box, which is used to identify the account as a ‘maintenance’ account. Maintenance accounts are intended to be used for car wash site employees, service providers and others that may need to use the wash but are not paying customers. The use of maintenance accounts is not accounted for in revenue calculations but these uses are counted in the accounting and house account reports for tracking.

5.5 Account Programs

The account programs option is used to set-up standard products for pre-paid, Site Lynx pre-paid, and subscription accounts (e.g. \$50 gift card, 5 wash pass etc). Once the program is set-up the ‘Accounts’ option can be used to issue or edit an individual account.

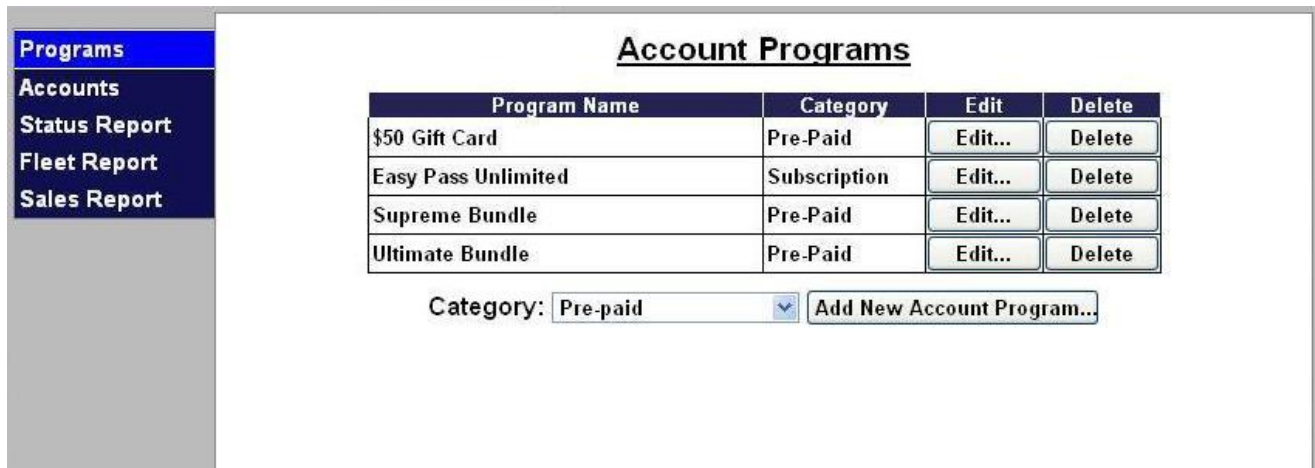

Figure 12. Account Program Screen

To setup a new account program, select from either Pre-paid, Subscription or Loyalty from the drop-down menu below the table and click Add New Account Program. The Edit Account screen will be displayed. To edit an existing account program, click Edit next to that program.

5.5.1 Pre-Paid Account Program Setup



Figure 13. Pre-paid Account Program Edit Screen

1. Enter the name of the account program.

2. Select the type of account from the drop-down menu. A product-based account is useable for only (1) wash product (which is selected from a drop down list). Monetary accounts can be used for any wash. **NOTE:** Prepaid accounts can be monetary or product based; subscription accounts are product based.
3. Enter the Issue Price (or selling price) that will be reported when a new account is issued (or sold) and then enter the Value for which the account can be redeemed. This field is not present on Subscription accounts.
4. You may limit the use and only allow a certain amount of washes per day, week, month or year. To do this, click Limit Use and enter the amount of washes and the time increment from the drop-down menu.
5. If you wish for the account to have an expiration date, click Enable, then enter the duration of the account program. **NOTE:** This schedule runs in calendar months. The account will expire on the last day of the month, not 30 days from the issue date.
6. If you wish to limit usage of the account to certain days and hours, click Enable under the schedule block and enter the valid times and days of the week.
7. Click Save.

5.5.2 Subscription Account Program Setup

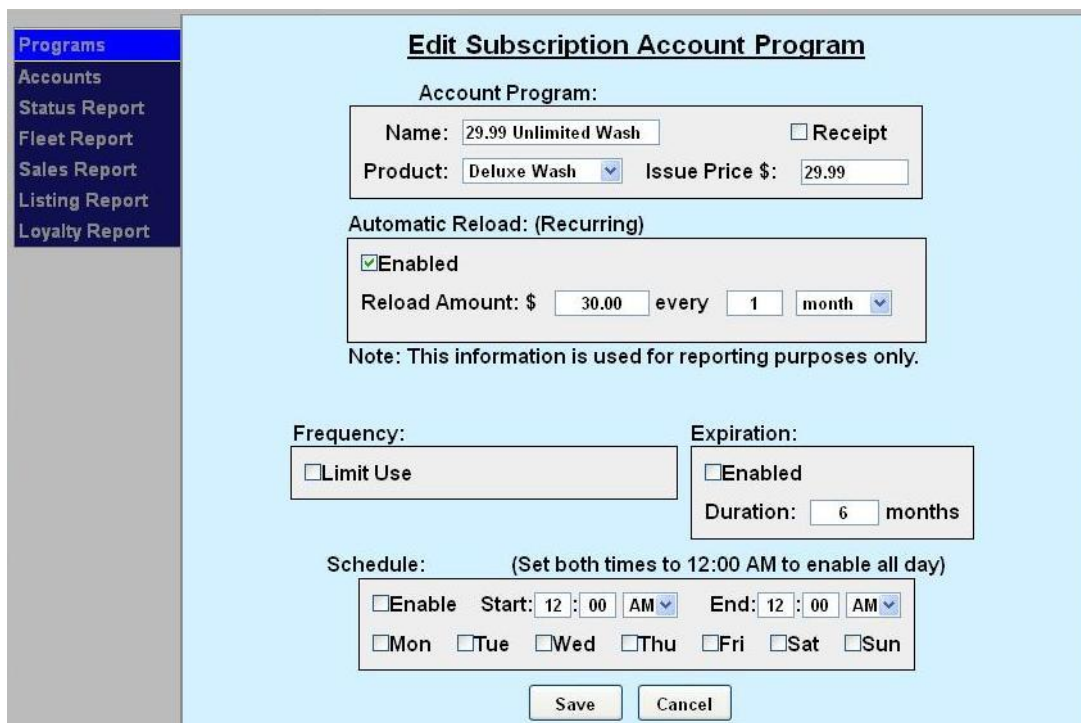

Figure 14. Subscription Account Program Edit Screen

1. Enter the name of the account program. Chose whether or not to force a receipt with each transaction.
2. Select the product from the drop-down menu.
3. Enter the Issue Price (or selling price) that will be reported when a new account is issued (or sold) and then enter the Value for which the account can be redeemed. This field is not present on Subscription accounts.
4. If desired, enable and enter the recurring bill amount. This amount will show up on reports ONLY. The entry unit WILL NOT automatically bill the customer, your credit processor wil.
5. You may limit the use and only allow a certain amount of washes per day, week, month or year. To do this, click Limit Use and enter the amount of washes and the time increment from the drop-down menu.
6. If you wish for the account to have an expiration date, click Enable, then enter the duration of the account program. **NOTE:** This schedule runs in calendar months. The account will expire on the last day of the month, not 30 days from the issue date.
7. If you wish to limit usage of the account to certain days and hours, click Enable under the schedule block and enter the valid times and days of the week.
8. Click Save.

5.6 Accounts

When the accounts option is selected, a list of current accountholders will be displayed along with search functions to find a specific account. To view details of an account, click Edit next to the account. To setup a new account, select the account type from Fleet, Pre-paid or Subscription from the drop-down menu below the table. For new Pre-paid or Subscription accounts, you may select a Program from the additional drop-down menu.

5.6.1 Prepaid and Subscription Accounts

For prepaid and subscription accounts, it's recommended that you first set up an account program, then select the program from the drop down list. Select add new account.

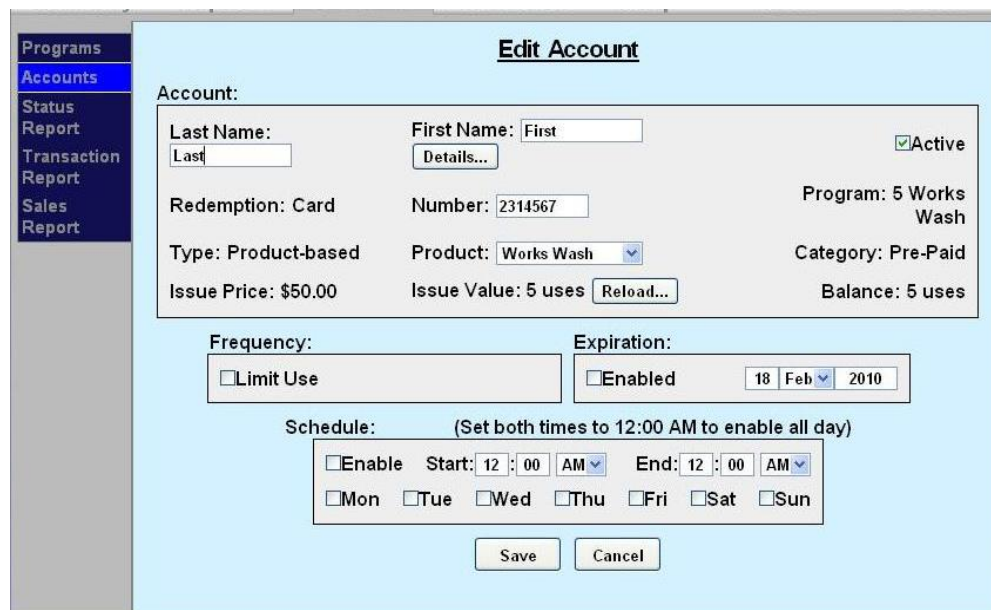

Figure 15. Prepaid Account Edit Screen

The account set-up page will show values that were set-up for the account program but additional data will need to be entered for the account holder as follows:

- Last and First name of the Account holder. A mailing address can be entered if desired by selecting the 'details' tab.
- Redemption method – select code, card, barcode or RFID (Subscription accounts only) from the drop down menu.
- Number – Enter code, card number or RFID tag number.

5.6.2 Loyalty Accounts

Accounts will be activated from the management pages by selecting the associated loyalty program and entering the customer-specific data, including:

- User name and contact details (address, e-mail etc.)
- Account Number
- Redemption method – Code, Card or RF Tag



Figure 16. Loyalty Account Setup Screen

5.6.3 Fleet Accounts

Fleet Accounts are set-up and managed directly through the 'Accounts' option (not the 'Programs' option). Account set-up is a 2-step process. The first step will be to set up and save the fleet business account. The 2nd step will be to add users (drivers) under the account. From the main Accounts page select Fleet as the account type and click the Add New Account button.

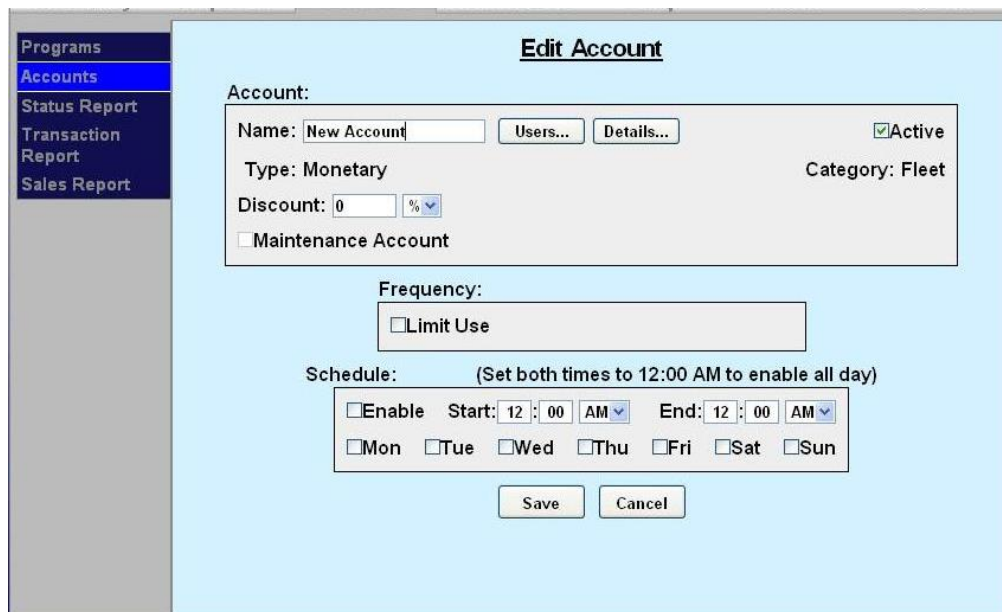

Figure 17. Edit Fleet Account

To set-up the fleet account:

1. Enter the business name for the account in the Name field.
2. Select the account type as monetary or product based. For product accounts, the associated wash product will need to be selected from the drop down list of available products.
3. Enter the value of discount that should be applied to the fleet customer's billing statement. Discounts can be set for a dollar value or a percentage.
4. Select 'maintenance' account if usage is not to be reported as revenue. **NOTE:** This account feature would typically be used for service providers and employees.
5. Select and enter usage limits, if desired.
6. If the account is only to be used during certain days or hours, enable and configure the account schedule.
7. Select the Details button and enter the billing address for the account, if desired.
8. Click save to save the account and return to the account listing.

To add or edit Users under a fleet account, find the account name in the account list and select edit. At the Account Edit page select the Users button. A list of current users will be displayed. Select the Add User function to get to the Edit Account User screen.



Figure 18. Edit Account User

To add a new user,

1. Enter the first and last name of the account user
2. Select the redemption method (code, card, barcode or RFID Tag)
3. Enter the code, card number or RFID tag number for the user
4. Click Save.

5.7 Account Reports

5.7.1 Status Report

A sample status report is shown below. This report will list all accounts that are set up in the account database with the following information:

- Account name and number
- Status – Shown as Active, Inactive (the account has been disabled by the car wash operator), Expired, or Exhausted (prepaid account with no remaining balance).
- Date the account was originally opened
- Expiration date (if account is configured to expire)
- Remaining Balance – shown as \$ value or number of uses, depending on the account type)

- Total uses since account was opened (as \$ value or number of uses, depending on the account type)

Summary	Reports	Accounts	Promotions	Setup	Sales	Utilities																																													
<div style="display: flex; justify-content: space-between;"> <div style="width: 20%;"> <p>Programs</p> <p>Accounts</p> <p>Status Report</p> <p>Transaction Report</p> <p>Sales Report</p> </div> <div style="width: 80%;"> <p style="text-align: center;">Account Status Report</p> <p>Site: Your Dealership Settings... Print Save</p> <p>Run Date: 4/14/2010</p> <table border="1" style="width: 100%; border-collapse: collapse;"> <thead> <tr> <th>Account Name</th> <th>Acct#</th> <th>Status</th> <th>Open Date</th> <th>Expiration</th> <th>Bal (\$)</th> <th>Bal (uses)</th> <th>Total (\$)</th> <th>Total (uses)</th> </tr> </thead> <tbody> <tr> <td>County Police</td> <td>---</td> <td>Active</td> <td>4/14/2010</td> <td>---</td> <td>---</td> <td>---</td> <td>---</td> <td>0</td> </tr> <tr> <td>Jones, Phil</td> <td>59632185</td> <td>Active</td> <td>4/14/2010</td> <td>---</td> <td>\$50.00</td> <td>---</td> <td>\$0.00</td> <td>---</td> </tr> <tr> <td>Smith, Ed</td> <td>89563214</td> <td>Active</td> <td>4/14/2010</td> <td>---</td> <td>\$50.00</td> <td>---</td> <td>\$0.00</td> <td>---</td> </tr> <tr> <td>Smith, Will</td> <td>65987423</td> <td>Active</td> <td>4/14/2010</td> <td>---</td> <td>---</td> <td>---</td> <td>---</td> <td>0</td> </tr> </tbody> </table> </div> </div>							Account Name	Acct#	Status	Open Date	Expiration	Bal (\$)	Bal (uses)	Total (\$)	Total (uses)	County Police	---	Active	4/14/2010	---	---	---	---	0	Jones, Phil	59632185	Active	4/14/2010	---	\$50.00	---	\$0.00	---	Smith, Ed	89563214	Active	4/14/2010	---	\$50.00	---	\$0.00	---	Smith, Will	65987423	Active	4/14/2010	---	---	---	---	0
Account Name	Acct#	Status	Open Date	Expiration	Bal (\$)	Bal (uses)	Total (\$)	Total (uses)																																											
County Police	---	Active	4/14/2010	---	---	---	---	0																																											
Jones, Phil	59632185	Active	4/14/2010	---	\$50.00	---	\$0.00	---																																											
Smith, Ed	89563214	Active	4/14/2010	---	\$50.00	---	\$0.00	---																																											
Smith, Will	65987423	Active	4/14/2010	---	---	---	---	0																																											

Figure 19. Sample House Account Status Report

5.7.2 Listing Report

This report allows you to export a list of account holders in .csv format. The exported file includes the account holder name and contact information, account number, and enrollment date.

5.7.3 Loyalty Report

The Loyalty Report provides a list of all members, their account numbers, uses, uses per month, and rewards information, plus any discount.

<u>Account Name</u>	<u>Account #</u>	<u>Uses</u>	<u>Uses/Month</u>	<u>Issued Rewards</u>	<u>Claimed Rewards</u>	<u>Expired Rewards</u>	<u>Average Discount</u>
Andrews, Ed	59632159	26	6.2	5	4	1	\$1.08
Bruschi, Ted	84965327	14	3.7	2	2	0	\$1.00
Carlson, Jim	65843215	9	4	1	1	0	\$0.78
Francis, Lois	33256984	6	2.8				\$1.50
Harris, Jane	54213985	4	2.2				\$2.00
Jackson, Lou	44869532	22	5.6	4	2	1	\$0.64
Ortiz, David	95487623	18	7.2	3	2	0	\$0.78
Smith, John	25644459	12	4.5	2	1	1	\$0.58
Wilson, Terry	15789652	7	5.6	1	1	0	\$1.00

Figure 20. Sample Account Loyalty Report

5.7.4 Fleet Report

The fleet report provides a list of all uses from one or more accounts over a user defined date range. This report is used to generate a statement for fleet account billing. A sample fleet report is below. The report shows a fleet application where the Police Department with multiple users is provided with a \$2 discount off of the (\$11) Deluxe wash.

Fleet Account Statement

Police Department

Billing Date: 11/30/2013
 Payment Due: 12/15/2013
 Amount Due: \$288.00

Remit payment to: Your Carwash
 1234 Main St
 City, ST 12345

User Name	Account No.	Date	Site	Product	Net Due
Admin 1	1234	12/20/2011	01	Deluxe	\$9.00
Admin 1	1234	1/7/2012	01	Deluxe	\$9.00
Admin 1	1234	1/7/2012	01	Deluxe	\$9.00
Admin 1	1234	1/21/2012	01	Deluxe	\$9.00
Admin 2	2345	12/18/2011	01	Deluxe	\$9.00
Admin 2	2345	12/31/2011	01	Deluxe	\$9.00
Admin 2	2345	1/21/2012	01	Deluxe	\$9.00
CID	3333	12/22/2011	01	Deluxe	\$9.00
CID	3333	1/23/2012	01	Deluxe	\$9.00
Patrol 1	0001	12/9/2011	01	Deluxe	\$9.00
Patrol 1	0001	12/9/2011	01	Deluxe	\$9.00
Patrol 1	0001	12/10/2011	01	Deluxe	\$9.00
Patrol 1	0001	12/10/2011	01	Deluxe	\$9.00
Patrol 1	0001	12/10/2011	01	Deluxe	\$9.00
Patrol 1	0001	12/10/2011	01	Deluxe	\$9.00
Patrol 1	0001	12/14/2011	01	Deluxe	\$9.00
Patrol 1	0001	12/17/2011	01	Deluxe	\$9.00
Patrol 1	0001	12/21/2011	01	Deluxe	\$9.00
Patrol 1	0001	12/21/2011	01	Deluxe	\$9.00
Patrol 1	0001	12/22/2011	01	Deluxe	\$9.00
Patrol 1	0001	1/11/2012	01	Deluxe	\$9.00
Patrol 1	0001	1/11/2012	01	Deluxe	\$9.00
Patrol 1	0001	1/11/2012	01	Deluxe	\$9.00
Patrol 1	0001	1/18/2012	01	Deluxe	\$9.00
Patrol 2	0002	12/9/2011	01	Deluxe	\$9.00
Patrol 2	0002	12/17/2011	01	Deluxe	\$9.00
Patrol 2	0002	12/28/2011	01	Deluxe	\$9.00
Patrol 2	0002	1/7/2012	01	Deluxe	\$9.00
Patrol 2	0002	1/7/2012	01	Deluxe	\$9.00
Patrol 3	0003	12/30/2011	01	Deluxe	\$9.00
Patrol 3	0003	1/18/2012	01	Deluxe	\$9.00
Patrol 3	0003	1/20/2012	01	Deluxe	\$9.00

Figure 21. Sample House Account Fleet Report

The Fleet Report contains the following information for the specified time period:

- Name of the fleet account

- Dates of billing, when the payment is due, and the amount due
- The payment address
- User Name and Account Number (either card, code or RFID tag)
- Day the car wash was used
- The wash package that was purchased. Usually, a wash package is assigned to the account in setup.
- Price of the wash package used. The price is totaled at the bottom of the column.
- Amount of discount that is applied to the account (if any). The discount is totaled at the bottom of the column.
- Net amount due for each wash package used. The net amount is totaled at the bottom of the column to show the total amount due for that billing period. This is the same amount listed at the top of the report.

5.7.5 Sales Report

Account Sales Report								
Site: Your Carwash					Settings...		Print	Save
Run Date: 1/26/2012								
Report Period: 1 Jan 2012 - 26 Jan 2012								
Account Name	Acct#	Program	Date	Sales Type	Value (\$)	Value (uses)	Price	Employee ID
Adams, John	38256083		1/14/2012	Issue	\$30.00	---	\$24.00	00
Washington, George	66913541		1/18/2012	Issue	\$100.00	---	\$70.00	00
Smith, John	52733161		1/14/2012	Issue	\$31.25	---	\$25.00	00
Smith, Jane	30622355		1/16/2012	Issue	\$52.00	---	\$40.00	00
Example, Ima	27274189		1/21/2012	Issue	\$35.00	---	\$28.00	01
\$100 Gift Card	29423077	\$100 Gift	1/18/2012	Reload	\$100.00	---	\$90.00	00
\$100 Gift Card	30761204	\$100 Gift	1/18/2012	Issue	\$100.00	---	\$90.00	00
\$100 Gift Card	56624211	\$100 Gift	1/18/2012	Issue	\$100.00	---	\$90.00	00
\$100 Gift Card	83847475	\$100 Gift	1/18/2012	Issue	\$100.00	---	\$90.00	00
\$100 Gift Card	82185278	\$100 Gift	1/18/2012	Issue	\$100.00	---	\$90.00	01
\$50 Gift Card	86037969	\$50 Gift	1/18/2012	Issue	\$50.00	---	\$0.00	00
\$50 Gift Card	72326034	\$50 Gift	1/18/2012	Issue	\$50.00	---	\$0.00	00
\$25 Gift Card	74354076	\$25 Gift	1/16/2012	Issue	\$25.00	---	\$20.00	00
\$25 Gift Card	50014935	\$25 Gift	1/16/2012	Issue	\$25.00	---	\$20.00	00
Parker, Peter	11657709		1/7/2012	Issue	\$20.00	---	\$16.00	00
Arthur, Chester	65738185		1/5/2012	Reload	\$50.00	---	\$40.00	00
West, Adam	49158965		1/15/2012	Issue	\$60.00	---	\$48.00	00

Figure 22. Account Sales Report

The account sales report provides a list of prepaid account sales and account reloads during a user defined date range. A sample report is shown above.

- Account Name and Number
- Program – indicates whether an account program was used for this account.
- Date – day account was purchased.
- Sales type -- indicates whether the entry is for a new account that was sold (issued) or a reload.
- Value – indicates the dollar amount or number of uses that were added to the account and the

- Price -- indicates the amount due from the account holder.
- Employee ID – indicates the system user who issued or reloaded the account.

5.7.6 Account Transaction Report

Account Transaction Report							
Site: Your Carwash				<input type="button" value="Settings..."/>		<input type="button" value="Print"/> <input type="button" value="Save"/>	
Run Date: 1/2/2014							
Report Period: 1 Sep 2013 - 31 Oct 2013							
Account Name	User Name	Acct#	Date	Location	Product	Discount	Net Amount
City Bus	Bus 5	11111111	9/17/2013	Your Carwash	Self Service Bay	\$0.00	\$20.00
	Bus 6	22222222	12/18/2013	Your Carwash	Self Service Bay	\$0.00	\$7.97
Total						\$0.00	\$27.97
Police Dept	Squad 1	12345678	9/6/2013	Your Carwash	Works	\$0.00	\$11.00
	Squad 2	23456789	9/9/2013	Your Carwash	Works	\$0.00	\$11.00
	Squad 1	12345678	9/16/2013	Your Carwash	Deluxe	\$0.00	\$8.00
	Squad 1	12345678	10/21/2013	Your Carwash	Works	\$0.00	\$11.00
	Squad 2	23456789	11/12/2013	Your Carwash	Works	\$8.00	\$3.00
Total						\$8.00	\$44.00

Figure 23. Account Transaction Report

The Account Transaction Report displays all transactions over a user defined date range. The report can be filtered to show transactions for all accounts, all accounts of a certain type (e.g. subscription, fleet ...) or a single account. Records shown can be sorted by account name or transaction date.

6 Reports

The Reports function allows you to view accounting information and product usage, filtered by ranges and dates you specify. When a report is generated, the associated data will appear on the screen with Print and Save functions. By selecting the Print button, you can print a copy of the report at your local printer. The Save function allows the report data to be saved in .CSV format so it can be viewed and/or sorted in standard 3rd party software applications (such as Microsoft Excel).

Revenue Report – Reports revenue at a summary level for a user-defined time period.

Sales Report –Lists items that were sold (e.g. Washes, Added Services, Wash Codes etc.) for a user-defined time period.

Cash Report – Daily report of cash received and dispensed by the Sentinel.

Transaction History – Listing of transactions recorded at the unit for a user-defined time period.

Code Listing – Listing of wash codes (sold at a C-store POS or Pump) currently stored in memory.



6.1 Site Revenue Report

Revenue reports can be generated for the current business day, previous day or for a user specified date range. From the report view, the user can print a report copy or save an electronic version in .CSV format. An example report is shown below with descriptions of the included data.

Sales Summary						Sales
Washes	<u>Qty</u>	<u>Paid</u>	<u>Revenue</u>	<u>Prepaid</u>	<u>Total</u>	<u>Net</u> <u>Avg</u>
Works	35	32	\$105.00	\$270.00	\$375.00	\$11.72
Supreme	44	41	\$96.00	\$290.00	\$386.00	\$9.41
Deluxe	28	27	\$55.00	\$150.00	\$205.00	\$7.59
Express	76	74	\$118.00	\$319.00	\$437.00	\$5.91
Total	183	174	\$374.00	\$1,029.00	\$1,403.00	\$8.06
Added Services						
Tire Shine	4	4	\$20.00	\$0.00	\$20.00	
Rain-X	7	7	\$21.00	\$0.00	\$21.00	
Rain & Shine	12	12	\$36.00	\$0.00	\$36.00	
Total	23	23	\$77.00	\$0.00	\$77.00	\$0.44
Automatic Totals			\$451.00	\$1,029.00	\$1,480.00	\$8.51
Self Serve						
Hand Bay	29	25	\$137.80	\$0.00	\$137.80	\$5.51
Vaccum	18	18	\$37.50	\$0.00	\$37.50	\$2.08
Self Serve Totals	47	43	\$175.30	0.00	175.30	\$4.08
Car Wash Totals	206	197	\$626.30	\$1,029.00	\$1,655.30	
Code Sales						
	<u>Qty</u>	<u>Paid</u>	<u>Sales</u>	<u>Average</u>		
Works	16	16	\$190.00	\$11.88		
Supreme	22	22	\$205.00	\$9.32		
Deluxe	37	37	\$290.00	\$7.84		
Express	42	42	\$252.00	\$6.00		
Code Totals	117	117	\$937.00	\$8.01		

Account Sales

	<u>Qty</u>	<u>Revenue</u>
\$25 Gift	7	\$175.00
5 Deluxe Card	3	\$120.00
5 Express Card	4	\$120.00
Total	14	\$415.00

Accounts Reloads

5 Deluxe Card	8	\$320.00
5 Express Card	5	\$150.00
Total	13	\$470.00

Site Totals	<u>Revenue</u>	<u>Prepays</u>	<u>Subscription</u>
	\$2,448.30	\$1,029.00	0.00
Tax Collected	38.55		
Total payments	\$2,486.85	\$1,029.00	0.00
Fundraisers Due	(\$7.00)		
Net Revenue	\$2,479.85	\$1,029.00	0.00

Figure 24. Sample Site Revenue Report

Sales Summary - Provides a wash count, breakdown of purchased and pre-paid transactions, and average sales value. The prepaid column includes prepaid house accounts and 3rd party gift cards (through Mercury Payment Systems). Added services and serf serve (if applicable) totals are also displayed.

Average sales metrics are provided with and without discounts applied and the value of all discounts is identified. This value includes promotions and any discounts provided to fleet customers.

Code Sales - Provides a breakdown of washes purchased from the pumps and registers.

Account Sales - Provides a breakdown of accounts offered on the sales screens

Account Reloads – Provides a breakdown of accounts that were re-purchased at the sales screen.

Site Totals – Displays the total of all revenue, pre-paid accounts, and subscription accounts (if any).

Tax Collected – Displays the total taxes charged for credit purchases (if required in your state).

Fundraisers Due - Identifies any amounts due from the use of fundraiser promotion types.

Net Revenue - Identifies the net revenue, with taxes and fundraisers subtracted from the previous sales totals.

6.2 Sales Report

The Sales report shows the products that were purchased in the reporting period. This report can be generated for a specific payment device or for all devices on site. The available report periods are current day, previous day or a user-specified date range. Sales reports can be printed or saved in .CSV format. An example report is shown below with descriptions of the included data.

Sales Report										
Site: Your Carwash				<input type="button" value="Settings..."/>		<input type="button" value="Print"/>		<input type="button" value="Save"/>		
Run Date: 26 Jan 2012				Report Period: 1 Dec 2011 - 1 Dec 2011						
Device(s): All Devices										
Wash Activations										
	Product	Purchases	Code Use	Maintenance	Total	Usage				
	Express Wash	2	0	0	2	6.06 %				
	Super Wash	3	0	0	3	9.09 %				
	Deluxe Wash	6	0	0	6	18.18 %				
	Works Wash	22	0	0	22	66.67 %				
	Total	33	0	0	33	100 %				
Self Serve Activations										
	Product	Count	Cash		Credit		Account		Maintenance	
			Avg.	Count	Avg.	Count	Avg.	Count	Avg.	
	Self Serve Wash	11	10.9 min	3	12.82 min	0	0 min	0	0 min	
	Dog Wash	3	5.82 min	1	10.57 min	3	8.62 min	0	0 min	
Added Services										
	Product	Count	Usage							
	Total	0	0 %							
Prepaid Upgrades										
	Product	Count	Amount	Usage						
	Express Wash	0	\$0.00	0 %						
	Super Wash	0	\$0.00	0 %						
	Deluxe Wash	0	\$0.00	0 %						
	Works Wash	0	\$0.00	0 %						
	Total	0	\$0.00	0 %						
Code Sales										
	Product	Pump	C-Store	Remote Console	Total	Usage				
	Express Wash	0	0	0	0	0 %				
	Super Wash	0	0	0	0	0 %				
	Deluxe Wash	0	0	0	0	0 %				
	Works Wash	0	0	0	0	0 %				
	Total	0	0	0	0	0 %				
Payments										
	Type	Count	Usage							
	MasterCard Credit	10	18.52 %							
	Visa Credit	5	9.26 %							
	Debit	0	0 %							
	Cash	21	38.89 %							
	Discount	0	0 %							
	Fundraiser	0	0 %							
	Fleet Account	0	0 %							
	Prepaid Wash	0	0 %							
	Prepaid Account	10	18.52 %							
	Free Wash	6	11.11 %							
	Special	0	0 %							
	Subscription Account	2	3.7 %							
	Total	54	100 %							

Figure 25. Sample Sales Report

Wash Activations - Provides a count of washes dispensed, broken down by wash type, and includes washes dispensed using codes or maintenance accounts. The usage metric shows the percentage of activations for each wash type. Self-serve wash packages are displayed by purchase type - cash, credit, house account, or maintenance account.



Added Services - Provides a count of added services that were purchased, broken down by service type. The usage metric shows the percentage of customers that selected the service.

Prepaid Upgrades – Provides a count of and dollar amount earned for upgrades purchased with a wash package. The usage metric shows the percentage of activations for each wash type.

Code Sales – Provides a count of code sales and is displayed by POS device – pump, c-store register, or remote console. The usage metric shows the percentage of activations for each wash type.

Payments - Provides a list of payment methods used with the percentage of use (based on \$ value).

6.2.1 Cash Report

The cash report provides details on cash, coupons and tokens that were received and dispensed during the business day. The report can be generated for the current day (as a real time snapshot) or for any previous day. An example report is shown below with descriptions of the included data.

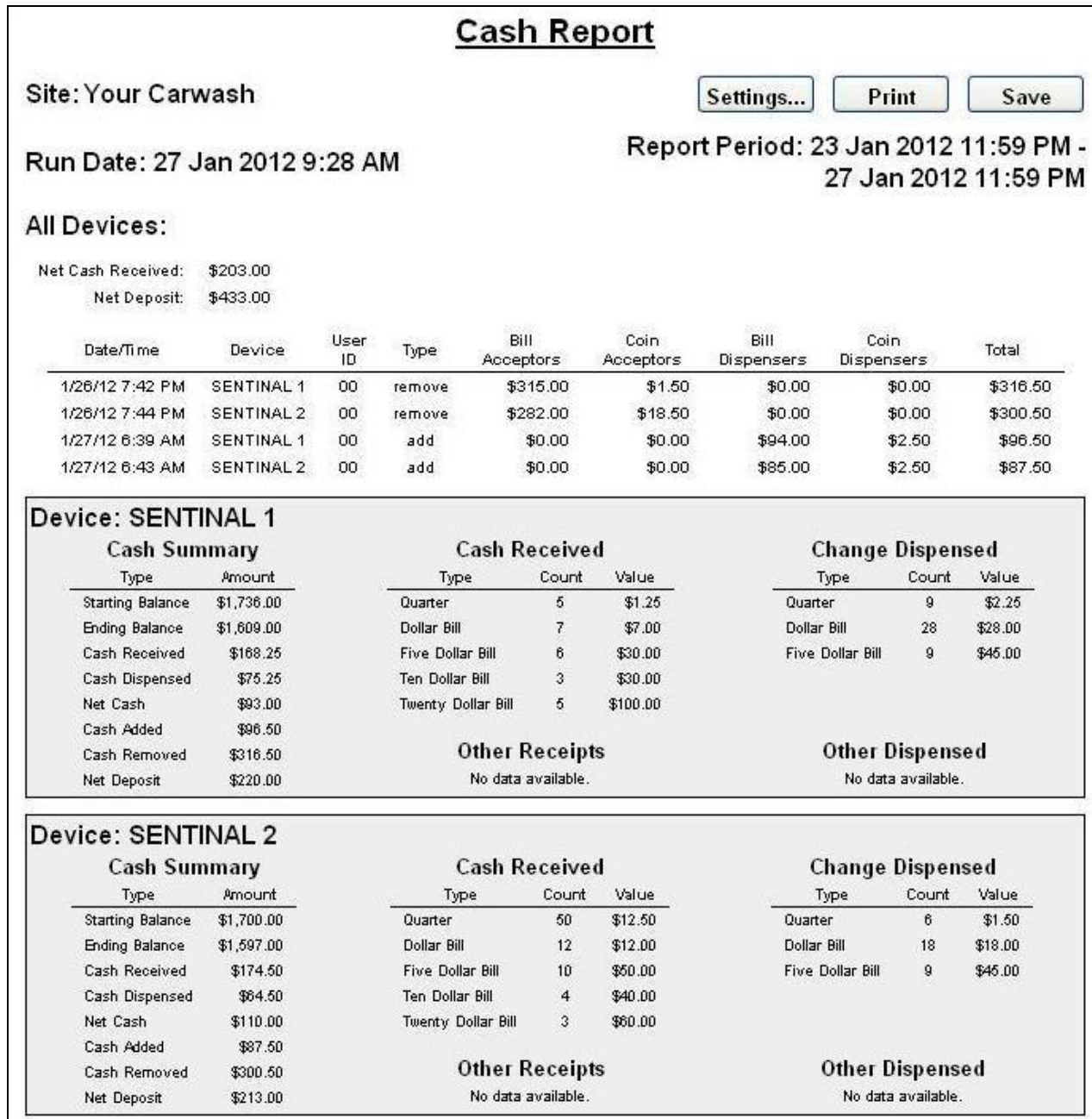

Figure 26. Sample Cash Report

The top section displays the cash adjustments record that is generated when an employee uses the cash removal or deposit functions (from the Maintenance functions) to restock change devices or remove cash from a cash acceptor or dispensing device. The adjustment record shows the date and time of the event, the user ID of the employee that performed the adjustment, and lists the amount of cash that was added or removed. The total amount of cash that was added and removed through these adjustments should match the associated entries in the Cash Summary section.

The bottom of the report displays the cash information for each device.

Cash Summary - Shows starting and ending balance of all cash in the unit (in both bill and coin acceptors and change dispensing devices). The amount of cash that was collected from customers is shown in the Cash Received entry. The Cash Added entry is the amount of cash that was added to restock change dispensers. The Cash Removed entry is the amount of cash that was removed from any of the cash devices (cash acceptors or change dispensers). If the Cash Added or Removed amounts are not zero, there should be a cash adjustment entry at the end of the report that provides a record of related events.

Cash Received - Provides a count and value of all cash received from customers, broken down by type and denomination.

Other Receipts - Provides a count of non-cash media (coupons, tokens) received from customers.

Change Dispensed - Provides a count and value of all change dispensed to customers, broken down by type and denomination.

Other Dispensed – Provides a count of tokens dispensed (if applicable).

6.2.2 Transaction Report

The transaction report provides a list of all transactions that were recorded over the reporting period. Reports can be generated for the current business day, previous day or for a user-specified date range. Additional filters are provided to refine reports include:

- Devices – show transactions for a single payment device on the site.
- Products – show transactions where a specific product (wash or added service) was purchased.
- Payment Type – show transactions where a specific payment type (cash, credit, house account etc.) was used. Additional filters are provided for some payment types to further refine the report to a specific account or account type.

An example report is shown below. The date, time, amount, device, product and any discounts applied are listed for each purchase. The payment column displays the specific payment types used. This column will show 'Multiple' for a transaction that included multiple payment types (i.e., split tender). The Account Name column (if applicable) will list the account holder's name for transactions that were paid with a house account. The Account column will display either the last four numbers of the credit card used or the house account used. The Transaction status will be shown as processed (transaction was completed),

cancelled (customer cancelled the transaction before it could be completed), or pending (transaction was started was not completed, still in process).

Transaction Report								
Site: Your Carwash				Settings...		Print		Save
Run Date: 27 Jan 2012				Report Period: 27 Jan 2012 - 27 Jan 2012				
Device(s): All Devices								
Date/Time	Amount	Device	Product(s)	Payment(s)	Discount	Account	Status	Details
1/27/12 09:29	\$11.00	SENTINAL 1	Deluxe Wash	MasterCard Credit	\$0.00	3416	Complete	details
1/27/12 09:23	\$11.00	SENTINAL 2	Deluxe Wash	MasterCard Credit	\$0.00	8380	Complete	details
1/27/12 09:20	\$11.00	SENTINAL 2	Deluxe Wash	Visa Credit	\$0.00	5742	Complete	details
1/27/12 09:19	\$7.00	SENTINAL 1	Express Wash	Cash	\$0.00		Complete	details
1/27/12 09:14	\$11.00	SENTINAL 1	Deluxe Wash	Visa Credit	\$0.00	4396	Complete	details
1/27/12 09:02	\$11.00	SENTINAL 1	Deluxe Wash	Remote POS Code	\$0.00	POS 1	Complete	details
1/27/12 08:55	\$11.00	SENTINAL 2	Deluxe Wash	Remote POS Code	\$0.00	POS 1	Complete	details
1/27/12 08:37	\$9.00	SENTINAL 1	Super Wash	Visa Credit	\$0.00	8207	Complete	details
1/27/12 08:20	\$11.00	SENTINAL 1	Deluxe Wash	Remote POS Code	\$0.00	POS 1	Complete	details
1/27/12 08:09	\$11.00	SENTINAL 1	Deluxe Wash	Remote POS Code	\$0.00	POS 1	Complete	details
								1 2 3

Figure 27. Sample Transaction Report

When the transaction report is viewed, a “details” link will be displayed for each record. By clicking on this link, the user can view and print a more detailed record of the transaction. An example of this detailed view is shown below.

Transaction Details										
Site:										Print
Started: 1/27/2012 9:19:32 AM										
Completed: 1/27/2012 9:19:38 AM										
Total: \$7.00										
Status: Complete										
Products										
Name	Type	Rate	Quantity	Device						
Spit Bath	Wash	\$7.00	1.00	SENTINAL 1						
Payments										
Type	Amount	Media	Acct#	Expires	Ref#	CC	Status	Acct Name	User Name	
Dollar Bill (dispensed)	\$3.00	Bill					Complete			
Ten Dollar Bill (received)	\$10.00	Bill					Complete			
Done										

Figure 28. Sample Transaction Details

6.2.3 Code Listing Report

The code listing report is applicable to sites that use the optional POS interface or console for wash code sales. It can be used to check the status of a specific code by entering all or part of the code number. To generate a complete list of wash codes in memory, leave the code field blank and select the Run report button.

Code Listing Report

Site: Your Carwash Run Date: 3/23/10 13:25

Code	Status	Expires	Issue Date	Redemption Date	Product	Source	Issued By
66370	Used	3/30/10	3/23/10	3/23/10	Express Wash	POS	Register
11644	Used	3/30/10	3/23/10	3/23/10	Express Wash	POS	Register
76806	Used	3/30/10	3/23/10	3/23/10	Express Wash	POS	Register
65289	Used	3/30/10	3/23/10	3/23/10	Deluxe Wash	POS	Register
183026	Used	3/30/10	3/23/10	3/23/10	Express Wash	POS	Register

Figure 29. Sample Code Listing Report

The wash codes currently stored in memory are listed in chronological order. The code status will be shown as Active, Used or Expired. The Expires column displays the date the code expires. The Issue Date column displays the date the code was issued. The Redemption Date displays the date the code was used if any. The Product column displays the wash package sold. The Source column will indicate whether the code was sold from a console, C-store POS register or purchased at the pump. For codes sold at the console, the 'Issued by' column will show the user ID of the attendant that issued the code ticket. If more than 15 records are returned for the report query, use the page navigation at the lower right corner of the table.

7 Sales

The Sales tab displays and functions as a Point of Sale console interface. You must first set up the Sales screen in the POS Interface in order for this screen to be populated. For further instruction, please see Section 3.6.



Figure 30. Sales Screen

The Sales screen function keys are color-coded. Washes are blue and reports are red. Account, reloads, rewashes and the check and void code functions are teal.

To purchase a wash package, select one of the washes then click Purchase.



Figure 31. Purchase Wash Package Screen

A code will be generated and displayed on the screen. You may then print the code from the POS printer or from the print function of your PC.



Figure 32. Wash Purchased Screen

To purchase a new account, click on the account:

Select the redemption method

CARD **CODE**

CANCEL

Number:

User Name:

Account Program: *Ultimate Pack*

Expires:

Price: \$5.00

Balance: 2 (uses)

Figure 33. Account Purchase

1. Select code or card.
2. Enter the account number.
3. Enter the account holder's name.
4. Click Purchase to finalize the account purchase.

To reload an account, click Reload and enter the account number.

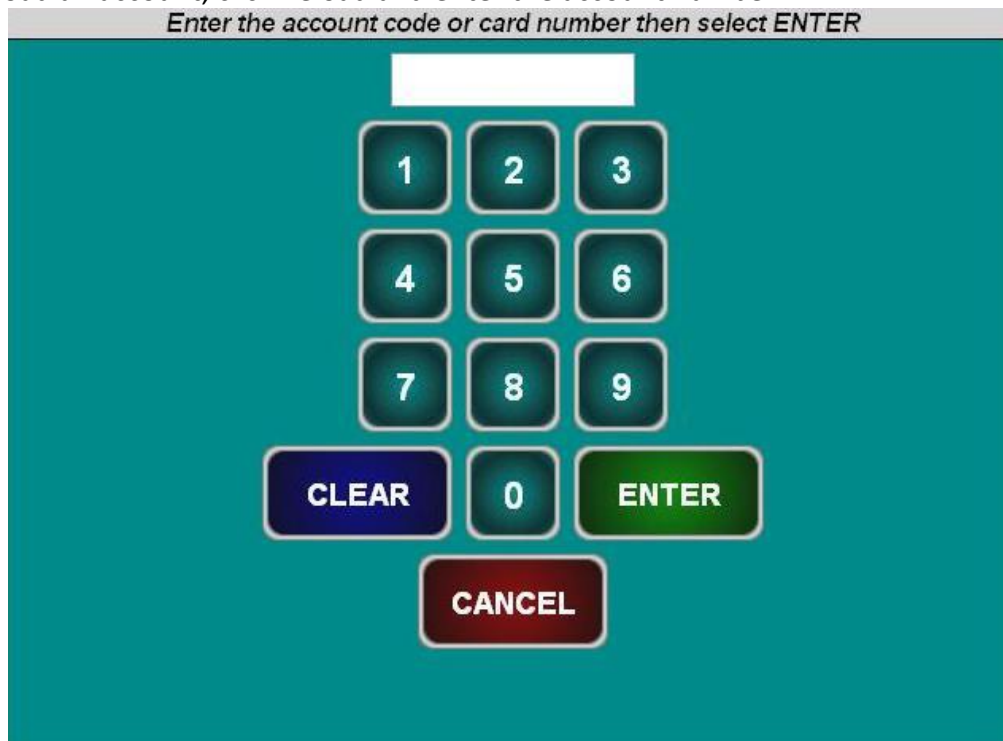

Figure 34. Reload Account Screen

Ensure the account holder's information is correct, then click Reload.

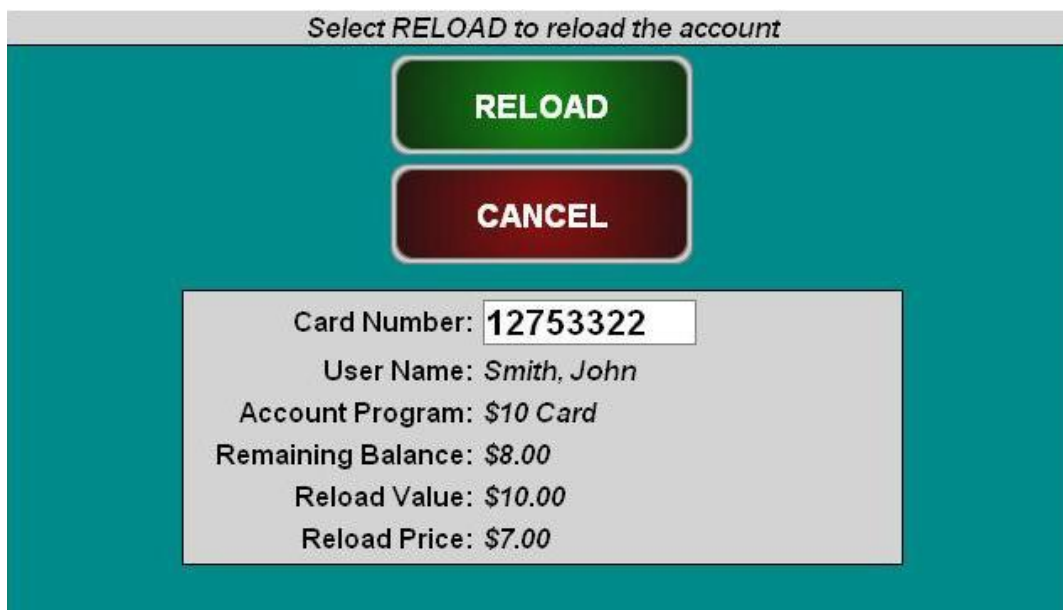

Figure 35. Reloaded Account Screen

To issue a rewash code, click Rewash then select the wash to issue the code:



Figure 36. Rewash Selection Screen



Figure 37. Rewash Code Issued Screen

To print a report, select the report type. If you would like to select a date other than the current day, select Change Dates. You may select the current day, select the previous day, or select a date range, then click Done, then Print Report. **NOTE:** The Report functions on the Sales page are for console users **ONLY**.

Specify the start/end dates then select DONE



The screenshot shows a teal background with four buttons: 'Current Business Day', 'Previous Business Day', 'Specify Start Date', and 'Specify End Date'. Below these is a white box containing 'Start Date: 23 Jan 2012' and 'End Date: 23 Jan 2012'. At the bottom are 'Done' and 'Cancel' buttons.

Figure 38. Report Date Selection Screen

8 Maintenance Functions

The Maintenance screen displays the current status of the devices located in the Sentinel unit. This screen is only accessible from the Sentinel, and will appear after you turn the key in the lock and login to the unit or by entering the code 4401 at the Sales screen.

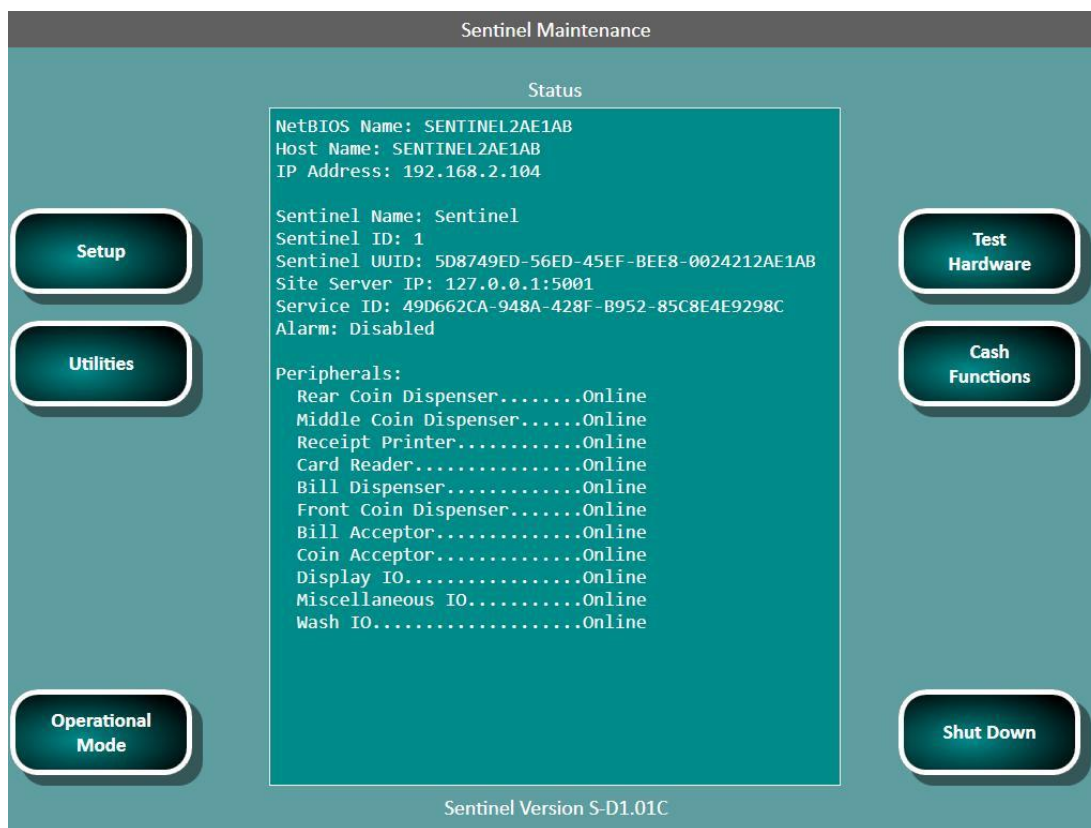

Figure 39. Sentinel Maintenance Screen

The Sentinel Maintenance screen provides access to the following screens. To display these screens, press the button beside the item you wish to display.

Setup – This key allows you to access the Management System pages to edit Sentinel configuration settings, designate the Sentinel as the master, and to run a ping test to the Sierra Server (that’s running on the master Sentinel).

Utilities --This key allows you to transfer files to and from a flash drive and to view the Sentinel logs.

Operational mode – This key returns the Sentinel to the Welcome screen. The system will remain in the operational mode until it senses the door key switch has been “removed” again, or at the close of the next transaction. A log will be created when the operational mode button is used. Note that the vault door must be closed (not necessarily locked) before Operational mode can be entered.

Test Hardware – This key brings up the screen to test installed devices.

Cash Functions – This key allows an authorized user to deposit or remove cash from the Sentinel vault. This will reset the cash totals.

Shutdown – This key is used to shut down, restart the Sentinel unit, or reload the device profile without having to open the door. (Note: The shut down function should always be performed before turning off power to the Sentinel).

8.1 Cash Functions

Cash functions allow an authorized user to deposit or remove cash into or from the Sentinel vault. This will reset the cash totals. (**Note:** the Cash function should be used whenever change is restocked or cash is removed from the Sentinel. Failure to do so will cause the cash report to be inaccurate and could cause false alert notifications to be sent).



Figure 40. Cash Deposit Screen

The Cash Deposit screen allows you to keep track of cash deposited into the Sentinel. All enabled coin and bill dispensers will display on the screen. Enter the amount for coins and bills in each slot then press OK. Upon completion of the deposit, the Sentinel printer will issue a receipt listing the amounts added and updated cash balances.

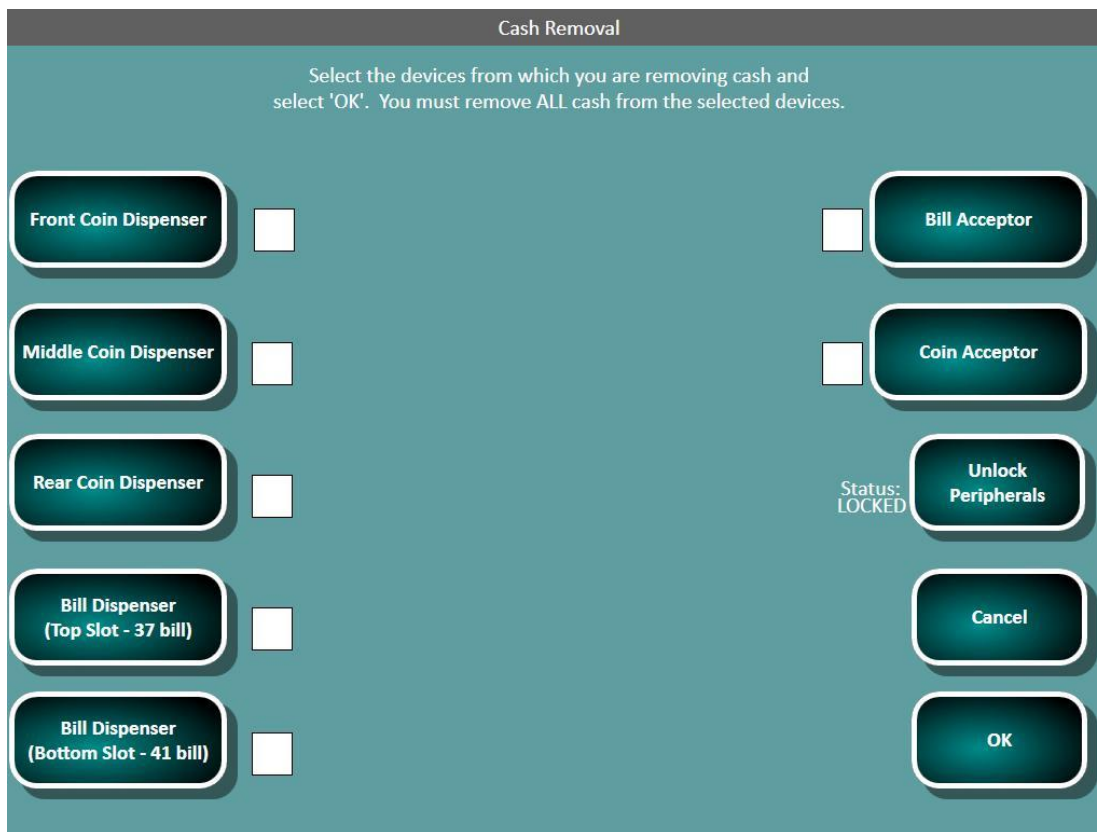

Figure 41. Cash Removal Screen

The Cash Removal screen allows you to keep track of the cash removed from the Sentinel. When removing cash, you must remove ALL cash from that selected device in order for the Sentinel to report accurate amounts. Select the device you wish to remove cash from and click OK. Upon completion of the withdrawal, the Sentinel printer will issue a receipt listing the amounts removed and updated cash balances.

If you have the bill dispenser installed, you **MUST** unlock the bill dispenser from this screen before attempting to remove cash from the cassettes.

8.2 Shutdown

The Shutdown feature allows you to shutdown or restart the Sentinel. Once the Sentinel software is shutdown, you may shutdown the unit at the main power switch inside the unit.

Note: The shutdown function should always be executed before powering off the Sentinel.

The reload feature allows you to reload the device profile.

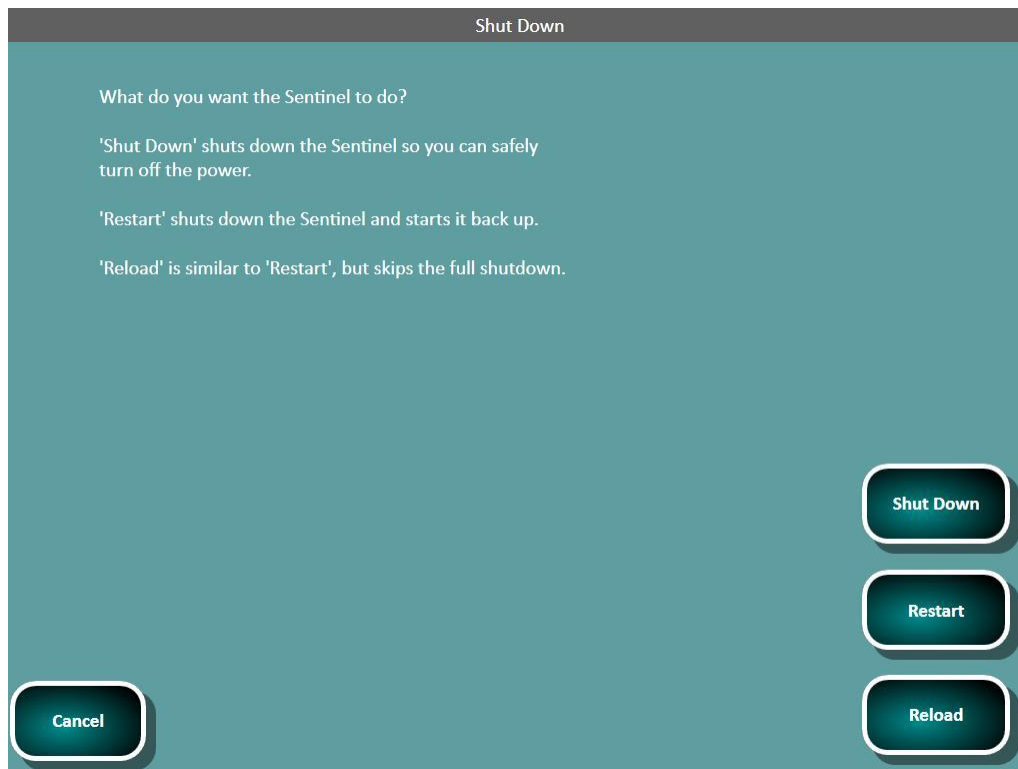

Figure 42. Shutdown Screen

9 Utilities

The Utilities tab allows you to view the current server version, view the current C drive version, view any hot fixes applied, view the IP address, set the system date and time, backup and restore the databases, view the event log, and upload software updates.

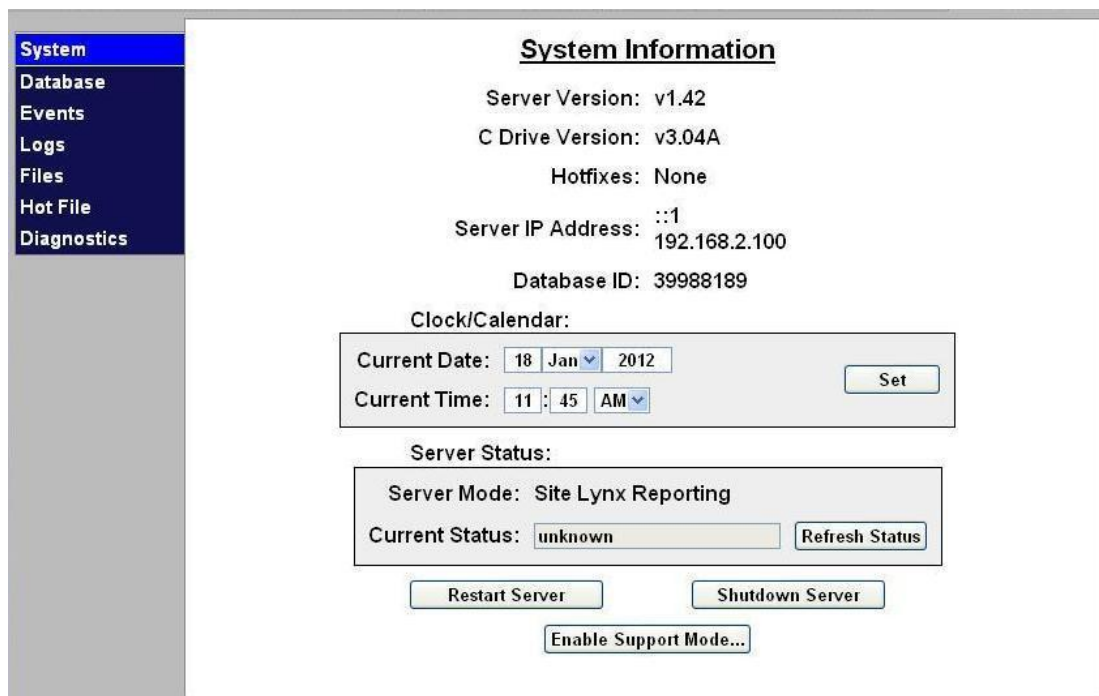

Figure 43. System Utilities Screen

The System Utilities screen displays the current installed server software version, installed hot fixes (if any), the server IP address as allocated by the router, and the database ID. It also displays the time and date and allows you to restart or shutdown the server from that screen without requiring a login to Maintenance Mode.

5. To set the calendar: enter the day, select the month from the drop-down menu, and enter the current year.
6. To set the current time: enter the hours and minutes then select AM or PM from the drop-down menu. Once the time is changed, you will be logged out and the time will be downloaded to any secondary devices.
7. To restart or shutdown the server, click the button. The system will confirm the restart or shutdown, then restart or shut down the server. All devices will go into Cash-Only mode.

8. **IMPORTANT NOTE:** For Portals and Sentinels, if the server is shut down, the primary unit running the server will shut down and all other units will go into Cash-Only mode. Be sure someone is on site to restart the primary unit.
9. **IMPORTANT NOTE:** For WashPay systems, ensure that there are no pending transactions before restarting or shutting down the server, or those transactions will be lost.

9.1.1 Enable Support Mode

Enable Support Mode is a feature that allows Unitec Customer Service to access and troubleshoot the server via remote access. If your devices are having problems, call Unitec Customer Support at 1800 Click the button to access the next screen.

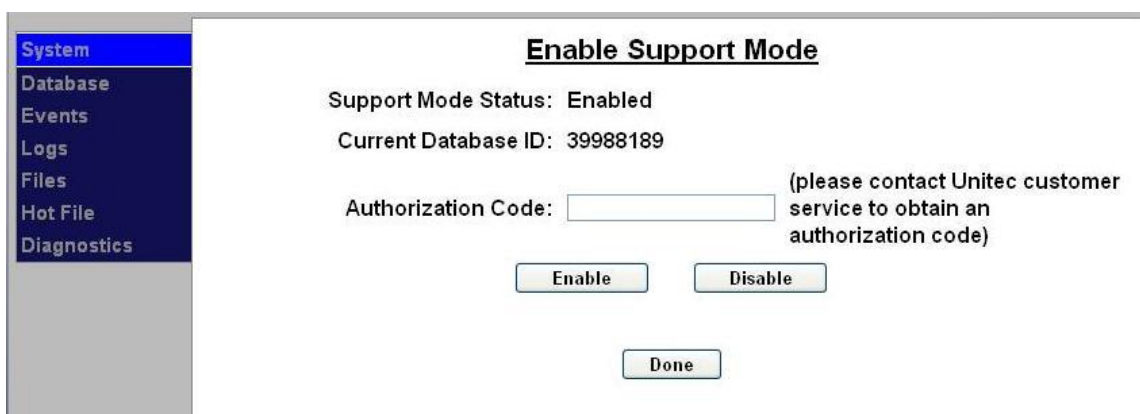

Figure 44. Enable Support Mode Screen

The Unitec Customer Support representative will provide a 16-digit authorization code to gain access to the server. Once that is entered correctly. Click Enable. Support Mode will automatically disable in 24 hours.

9.2 Database Management

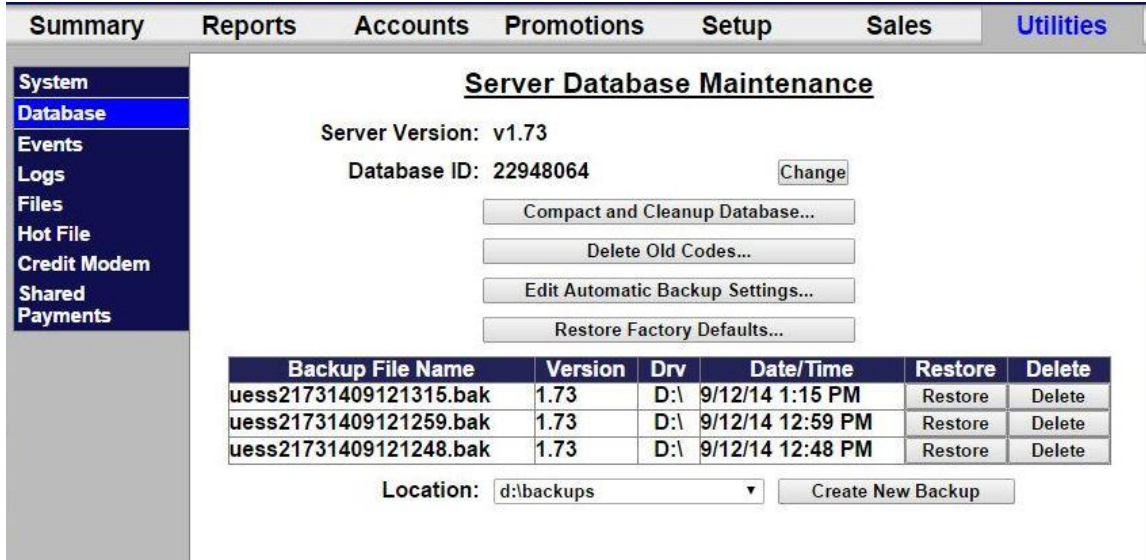

Figure 45. Database Utility Screen

The Database Utility screen is used to backup and restore the Sierra Server databases. Database back up files can be used to restore operation of the system in the event of a catastrophic event. To minimize the potential for lost sales data, regular back-ups should be performed. The software version, date and time of previously created back-ups are displayed on the screen.

9.2.1 Compact and Cleanup Database

The Compact and Cleanup Database function allows you to delete old transactions from the database. This will delete old information from reports and free up memory. To compact and cleanup the database:



Figure 46. Database Compact and Clean Screen

Enter a start date. Click Delete Transactions.

NOTE: All transactions prior to that date will be deleted, so make sure to create a database backup and hardcopy backups before performing this function.

9.2.2 Delete Old Codes

The Deleting Old Codes function allows you to erase old POS codes from the database to remove old unused codes from reports and free up memory. To delete old codes:



Figure 47. Delete Old Codes Screen

Enter the number of days. Click Delete Codes.

NOTE: All codes prior to that number of days will be deleted, so make sure to create a database backup and hardcopy backups before performing this function.

9.2.3 Automatic Backups Schedule for Server

To schedule Automatic backups, click on Edit Automatic Backup Settings.

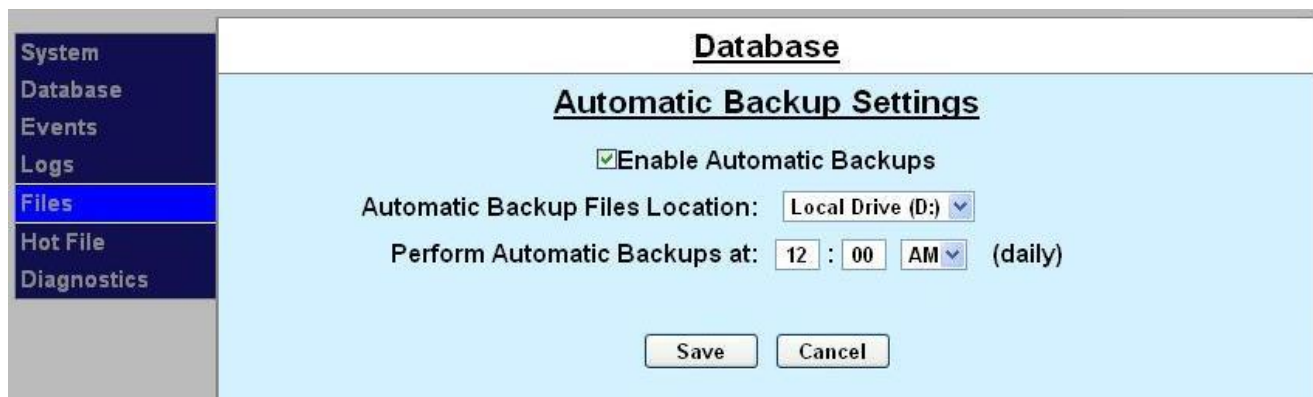

Figure 48. Automatic Backup Settings Screen

10. Click Enable Automatic Backups, then select the location, either the D drive or a thumbdrive, from the drop-down folder. Enter a time to perform the automatic backup. Click Save.
11. To create a backup: Make sure all devices are idle. You may choose where to save the backed-up data. To save backups on a separate device, a thumb drive should be connected to one of the USB ports on the primary carrier board.
12. **Note:** The thumbdrive MUST have a root folder named “backups” to backup data to it and restore from it.
13. Click the Create New Backup button below the table. Once the back up is saved, the devices will reload and the new back up will have been added to the screen. To delete an old database backup, click the Delete button next to that file name.
14. To restore the Sierra Server to a backed-up version of the database: Make sure all devices are idle. Click the Restore button next to the version you wish to restore. Once the database is restored, all devices will reboot.
15. **Note:** Any activity that occurred since the last back up will be written over by performing the Restore and that activity will be lost, including sales transactions and configuration changes.

9.2.4 Restore Factory Defaults

This function should only be used when advised to by Unitec Customer Support.

10 Component Operation and Maintenance

This section of the manual describes the normal operating procedures and basic troubleshooting and repair techniques for each of the system components. The following procedures are designed to provide you with the hardware troubleshooting and service information you need in order to provide your customers with the highest quality service possible.

When troubleshooting any issue, verify that the power supply is providing power to the affected component.



Caution: Only trained technicians should perform maintenance or repair procedures.

10.1 Component Layout

The following figures present the location of the Sentinel components. Some of these figures include optional features. Depending on the optional features purchased, specific unit components may vary.

10.1.1 Sentinel Doors

The door assembly contains the system components that provide direct access to the Sentinel. The following figure shows the front view of the door assembly with all visible components labeled.

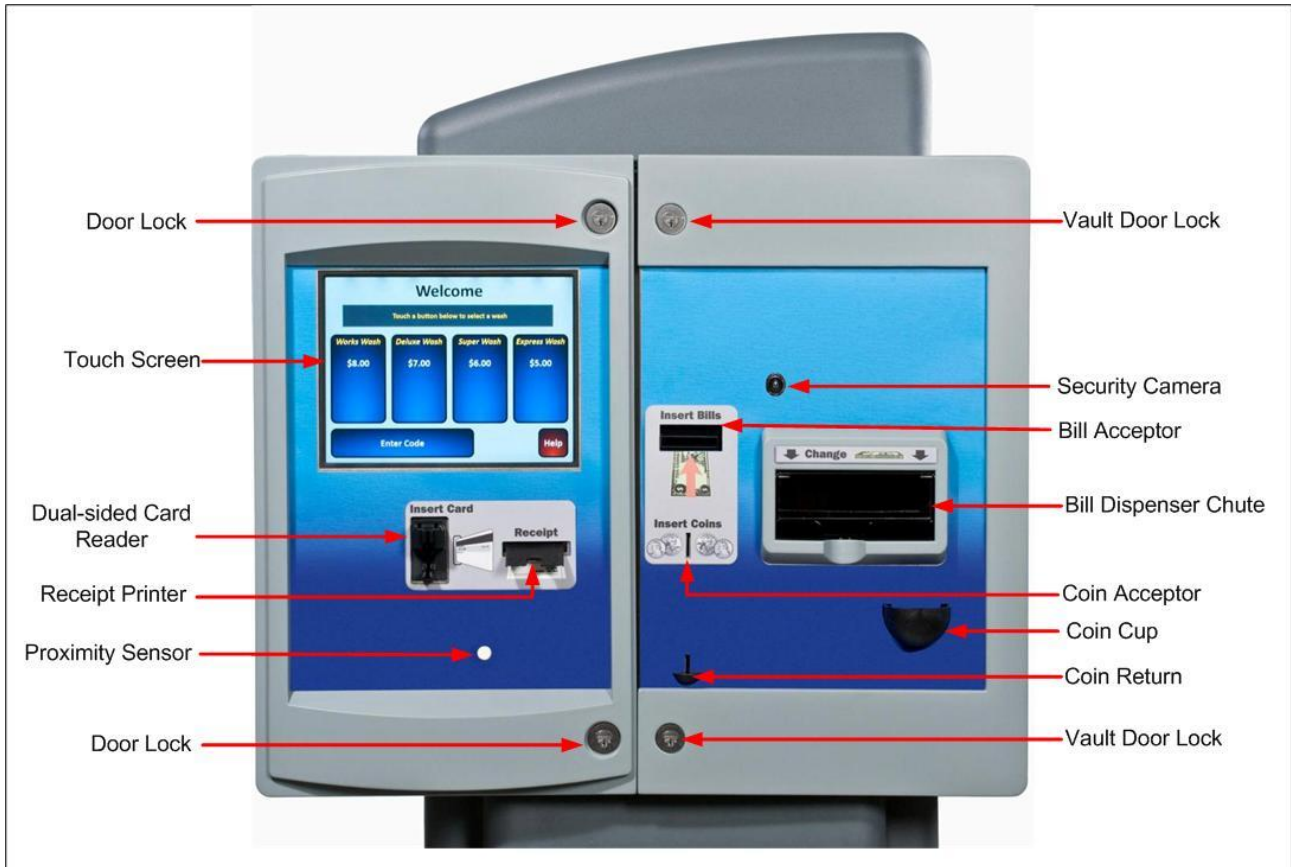

Figure 49. Sentinel Front View Visible Components

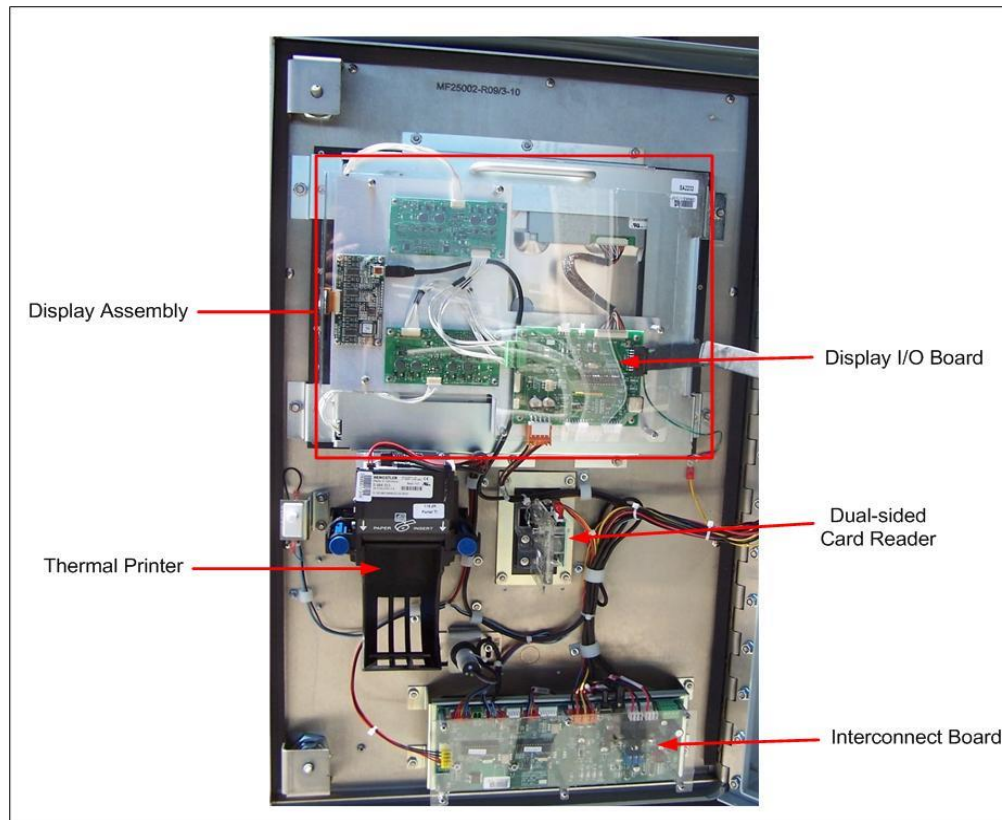

Figure 50.Sentinel Door – Left Interior

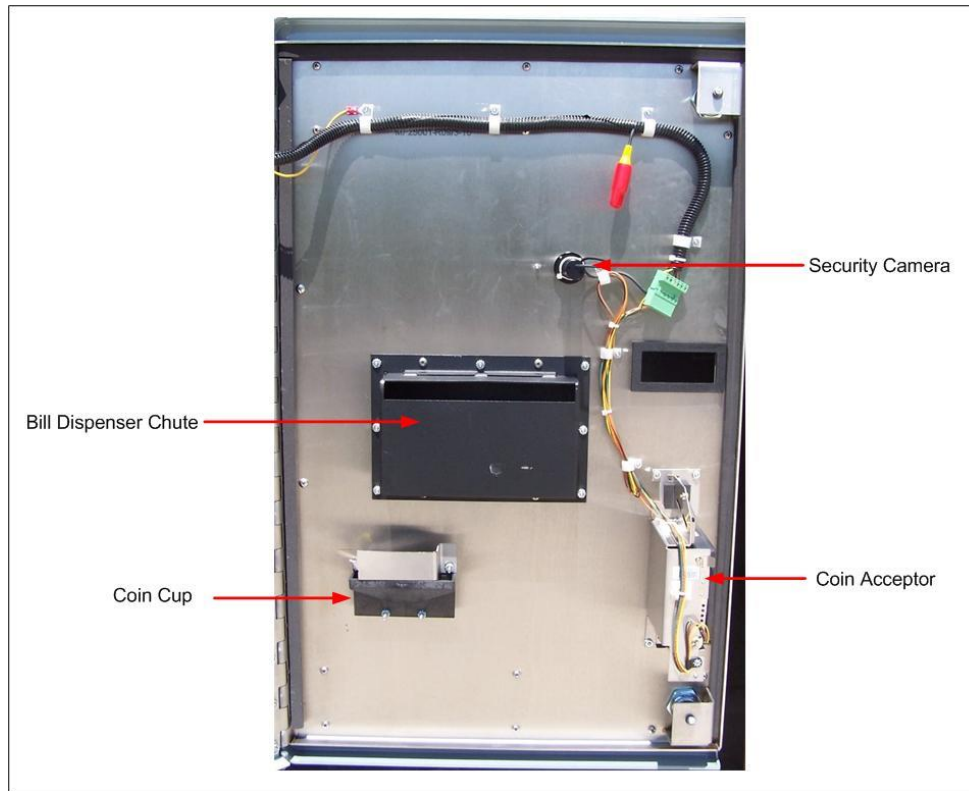

Figure 51. Sentinel Door – Right Interior

10.1.2 Inside the Sentinel

The following figure provides a photograph showing the components located inside the Sentinel. This drawing is intended to provide general component location information only.

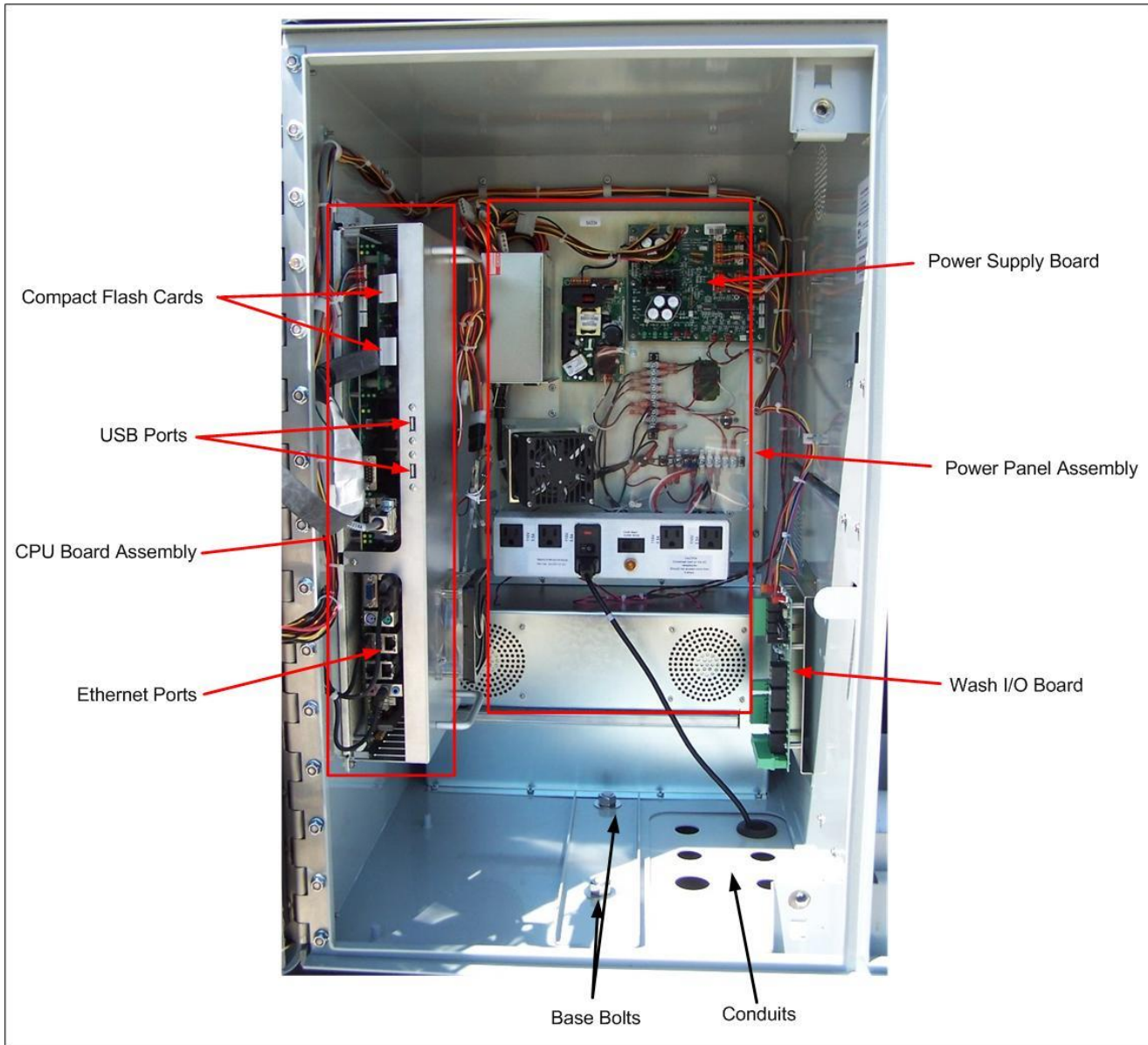

Figure 52. Electronic Components Inside the Sentinel Case (Left Side)

The cash vault is secured by Medeco locks on the top and bottom, and is wired to the system alarm to provide greater security. Inside the cash vault you will find the bill acceptor, coin acceptor, coin bin, coin hoppers, bill dispenser and miscellaneous I/O board.

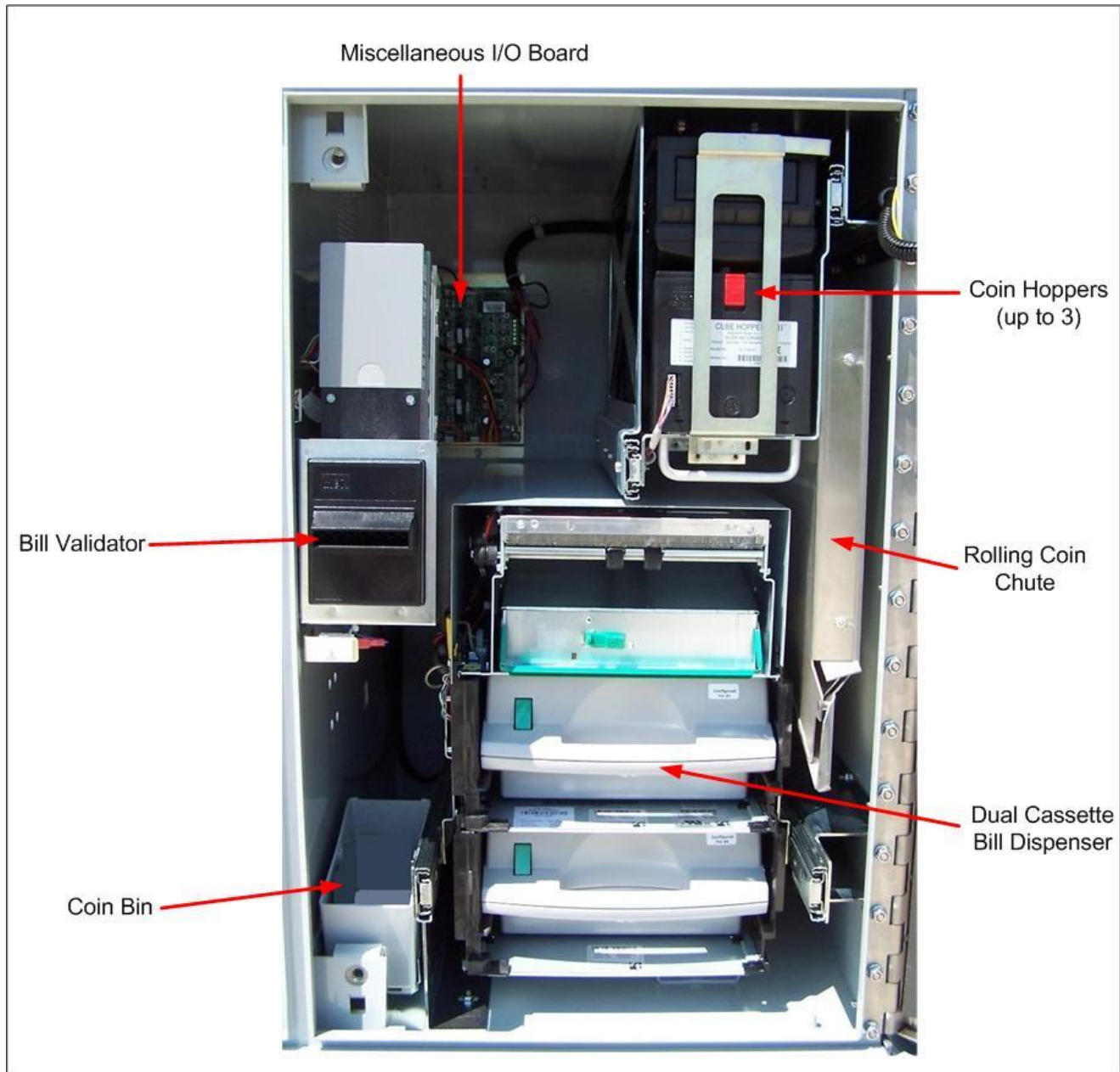

Figure 53. Components Inside the Cash Vault (Right Side)

10.1.3 System Cabling

System cabling comes into the Sentinel through the cable entrance ports located on the bottom left side of the unit as labeled in Figure 24. Wash cabling will be directly connected to the Wash IO Board at installation. The Ethernet cable, will be connected to the CPU board assembly at the Ethernet port.

10.2 Cleaning and General Maintenance

The Sentinel's plastic casing may be cleaned with a 1 to 1 solution of water and Simple Green® concentrate. Use a plastic brush in conjunction with the Simple Green® solution to clean the unit. After cleaning, rinse the solution off the unit using a low-pressure stream of water. Dark stains or colored gouges may be worked out of the plastic case or plastic door with a steel wool pad or Brillo® pad.

WARNING: Do not use a pressure washer to clean the unit.

WARNING: Do not direct water -- except in a small, downward stream -- into areas of the Bill acceptor, coin acceptor, receipt printer, bill dispenser chute, credit card reader, or touchscreen.

10.3 Bill Dispensers (Optional)

Cleaning and maintenance instructions for both the Talaris Dual Cassette Bill Dispenser and the LG Bill Dispenser are located in Appendices A and B, respectively.

10.4 Bill Validator

The bill validator allows customers to pay for their washes using bills. The standard Sentinel comes equipped with the MARS bill validation unit.

Removing the Bill Stacker

The bill stacker will hold up to 1,000 bills and is designed to allow quick and easy removal of stored money. To empty the bill stacker, hold the validator with one hand pushing the blue lock at the top of the validator with one of your fingers. With your other hand, lift the stacker upward to remove it.

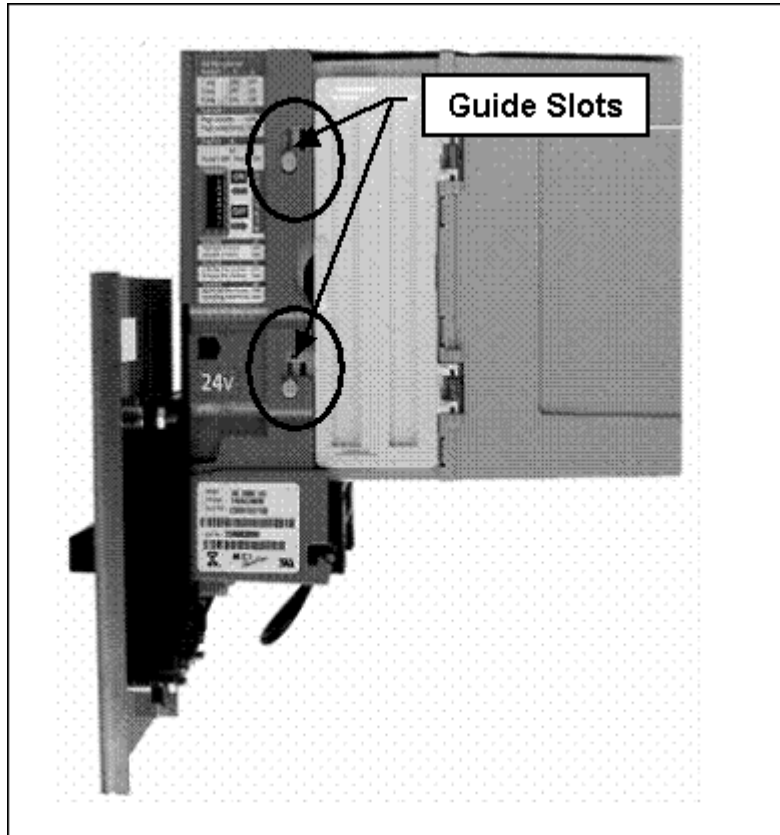

Figure 54. Mars Bill Validator/Stacker

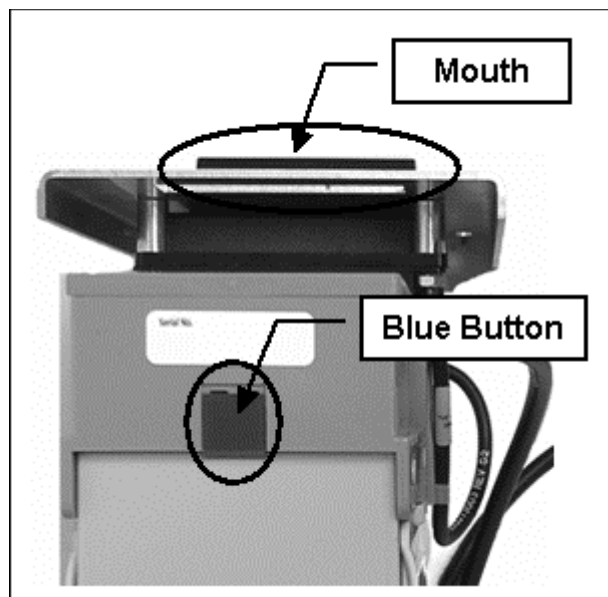

Figure 55. Mars Bill Validator—Top View

10.4.1.1 Replacing the Bill Stacker

To replace the stacker, perform the following steps:

1. Position the stacker behind the Mars Bill Validator with the hinged doors on the side, and the back of the stacker facing away from you.
2. Place the stacker against the bill validator.
3. Align the tabs on the bill stacker just above the guide slots on the bill validator.
4. Slide the stacker tabs into the guide slots, and then down until it is fully seated, as shown in the following figure.

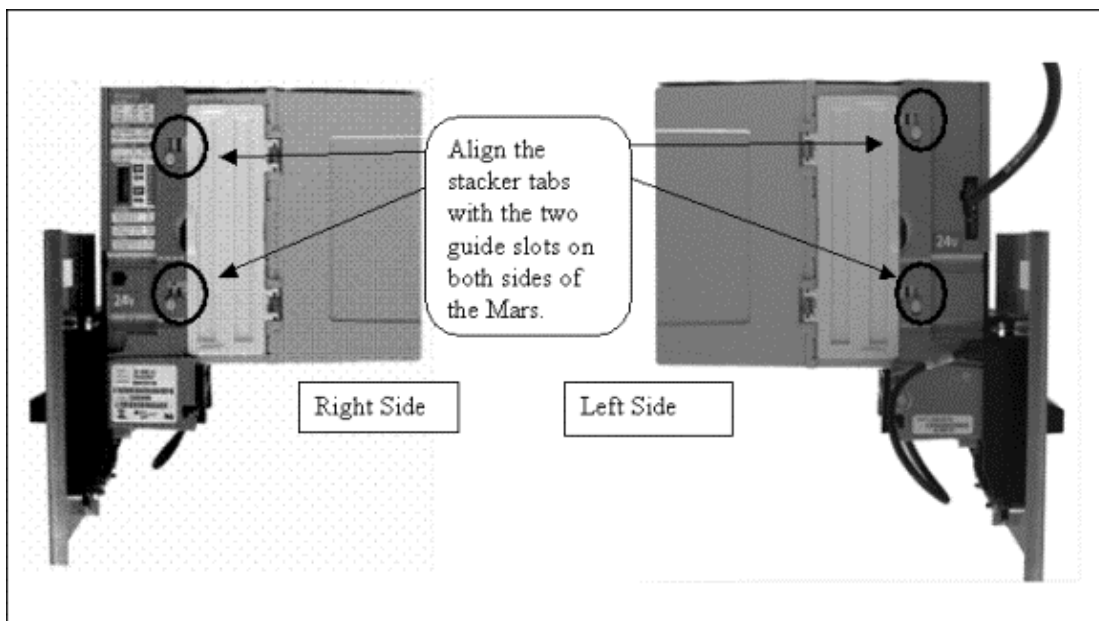

Figure 56. Mars Bill Stacker Replacement

10.4.1.2 Mars Bill Validator Flash Codes

The Mars Bill Validator is equipped with an internal diagnostic LED flash code system. This LED flash code system is used to alert the operator of a failure or to indicate a need for servicing.

The flash code LED is located in the lower section of the validator, below the stacker. See the following figure for the LED location.

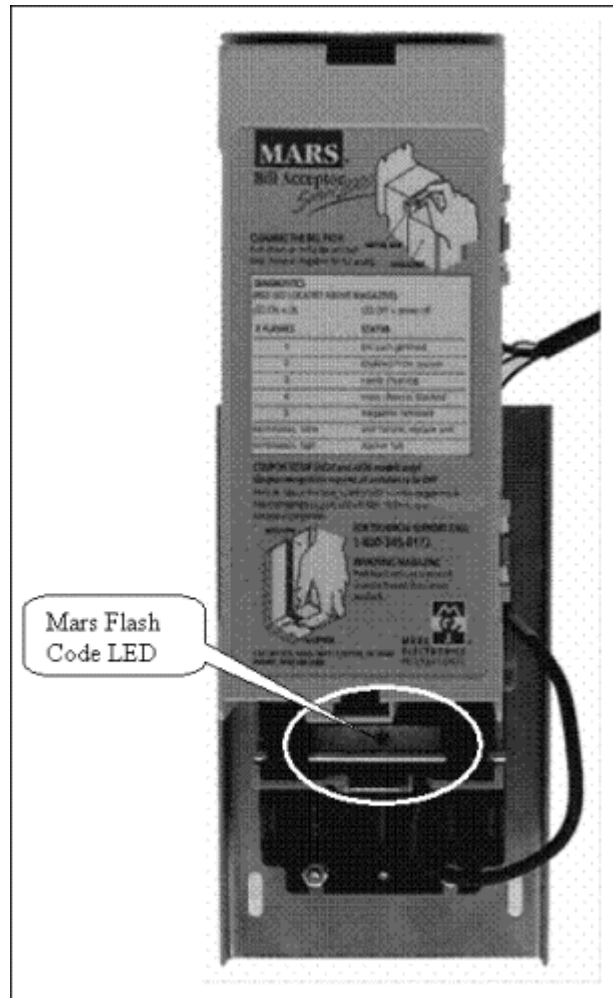

Figure 57. Mars Flash Code LED

The LED will repeat a specific number of flashes. Each number of flashes corresponds to a specific problem. The following table lists the meaning of each set of flashes. Many of these problems may be easily corrected without the need for technical assistance.

Table 1. Mars Bill Validator Flash Codes

# Flashes	Diagnostic Code Description
1	Bill path jammed
2	Disabled from system
3	Needs cleaning
4	Cross channel blockade
5	Magazine (stacker) removed

# Flashes	Diagnostic Code Description
Continuous slow	Unit failure, replace unit
Continuous fast	Stacker full
LED on	Ok
LED off	Power off

10.4.1.3 Removing the Mars Bill Validator From the Sentinel

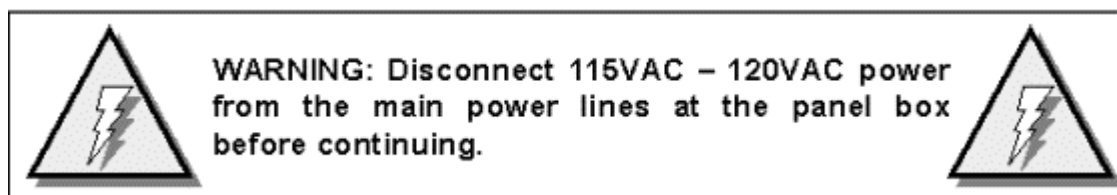

Perform the following steps to remove the Mars Bill Validator.

1. Open the cash vault.
2. Remove the bill stacker.
3. On the inside of the vault door, remove the four 5/16” mounting nuts on the sides of the Bill Validator.
4. Disconnect the Mars Bill Validator from the cable leading to the Miscellaneous IO board.

10.4.1.4 Removing the Mars Bill Validator Lower Housing

If necessary, the bill validator lower housing can be removed using the following procedures. The lower housing is the portion of the Bill Validator that sits just below the stacker and behind the bill mouth. The bill mouth is the part of the bill validator that is used to pull in and analyze the bills that have been inserted. Bills are pulled in by a system that draws them up into the main body. Once they have been pulled in, four photo-optic sensors are used to scan them and send the information to the electronics.

Perform the following steps to remove the Mars Bill Validator lower housing.

1. Remove the Bill stacker. (See Removing the Bill Stacker)
2. Reach under the bottom of the validator and locate a silver rod in the area below where the status LED is located.
3. Using your thumb, push the silver rod up toward status flash code LED.
4. Firmly grasp the top of the housing with your fingers and pull the lower housing toward the palm of you hand. (Be sure to keep steady pressure on the housing at all times during removal.)
5. Slide the inner housing out of the back of the validator, revealing the belts, pulleys and sensors.

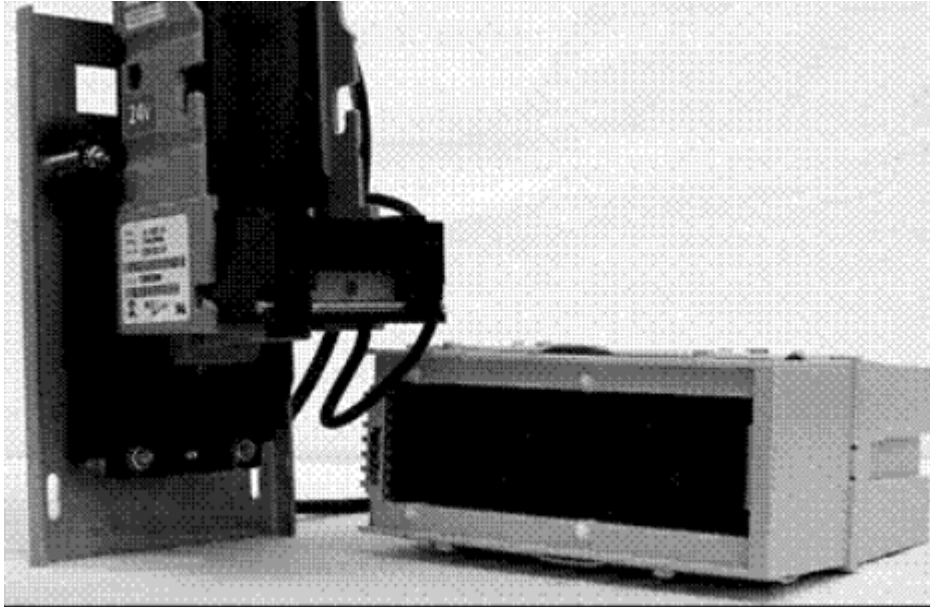

Figure 58. Mars with Lower Housing

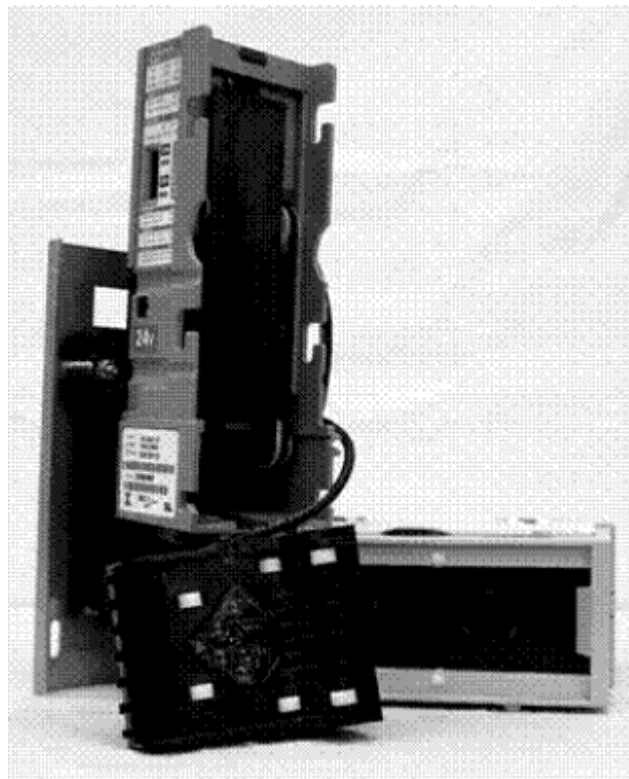

Figure 59. Mars with Lower Housing Removed

10.4.1.5 Cleaning and General Maintenance

The AE2600 series will not need cleaning as often as magnetic sensing bill validators. If cleaning is required, use a soft cloth moistened with mild, non-abrasive detergent.

10.4.1.6 Programming the Mars Bill Validator

WARNING: The DIP Switch settings are preconfigured at the factory, and should not be modified.

The Mars Bill Validator allows programming for a maximum-security setting, as well as a setting for a specified direction that a bill can be inserted. These options are set by a Dipswitch package located on one side of the validator.

To change any of the options, perform the following steps.

1. Remove the Mars Bill Validator from the unit. (See Removing the Mars Bill Validator for instructions.)
2. Referring to Table 7, use a small flat-head screwdriver to set the Dipswitches for the options you prefer. (See the following figure for dipswitch location.)

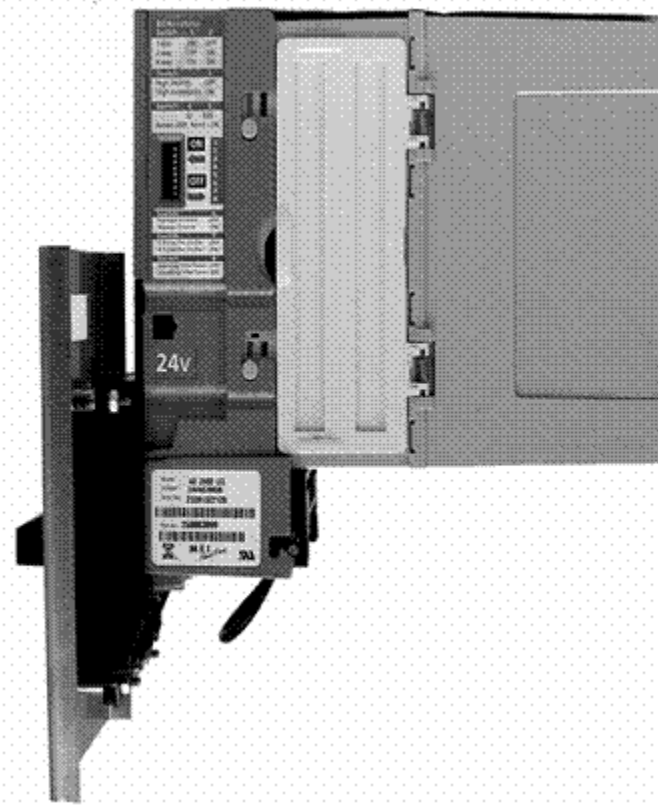

Figure 60. Mars DIP Switches

Table 2. Mars Bill Validator DIP Switches

Switch	ON	OFF	Default
1 & 2 (Switches work in combination)	1 & 2 both ON = 4-way bill acceptance	1 ON, 2 OFF = 1-way bill acceptance	OFF
		1 OFF, 2 ON = 2-way bill acceptance	OFF
3	High Acceptance	High Security	OFF
4	Reject \$2	Accept \$2	OFF
5	Reject \$20	Accept \$20	OFF
6	Always Enable	Harness Enable	OFF
7	4 Pulse per Dollar	1 Pulse per Dollar	OFF
8	Vending Interfaces	Gaming Interfaces	OFF

10.5 Card Reader

The card reader may be used with the Credit option or just for fleet cards and pass cards.

10.5.1 Cleaning the Card Reader

The internal card reader sensing devices accumulate dirt over time. As this happens, the credit card reader acceptance rate will begin to decline.

It is best to clean your card reader using card reader cleaning cards. These cleaning cards may be purchased directly from your distributor or from the manufacturer of the cleaner cards. The cleaner cards are Unitec stock #MS2031 and can also be purchased from Clean Team by calling 1-800-888-8830.

For the Panasonic card reader, insert and remove the cleaning card into and out of the card reader several times using both sides of the cleaning card because the Panasonic card reader can read the magnetic stripes from either side of the reader.

10.6 Coin Acceptor

The IDX coin acceptor allows the Sentinel to accept U.S. quarters, dollar coins and up to four different bi-metal tokens.

10.6.1 Coin Acceptor Cleaning and Maintenance

Check the coin-accepting system for proper operation each time you remove cash from the vault. Customers have been known to insert invalid coins, debris and bills into the coin box.

In addition, the two optical sensors must be cleaned periodically. Use a cotton swab daubed in isopropyl alcohol to wipe the inner wall area inside the first two inches of the coin slot.

If the unit malfunctions and a good cleaning does not solve the problem, reprogram the acceptor as described in Programming the IDX Acceptor.

The unit comes equipped to accept either U.S. quarters or dollar coins. The unit will also accept site-specific tokens.

In order to complete the programming you must have six of each of the tokens and coins you wish to accept. It is very important that you follow these directions exactly. The IDX acceptor will average the variances in these different sample coins during programming, and calculate a more accurate reference model. Using less than six different coins will invalidate the average variance generated by this process.

 **Note:** The IDX can ONLY be programmed with the Sentinel at the **Test Devices - Test Coin Acceptor screen**. When inserting coins into the IDX, you must be sure to close the cover completely.

Please refer to the block diagrams shown below while programming the IDX coin acceptor.

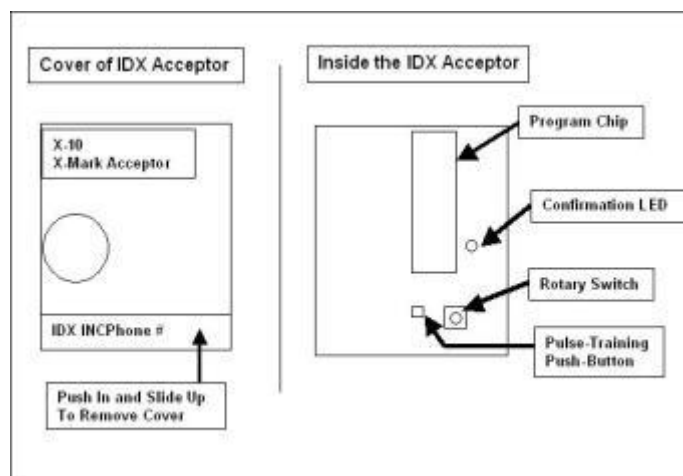

Figure 61. Outside/ Inside of the IDX

You must answer the following questions before proceeding with the programming of the IDX coin acceptor.

Do you want to accept tokens?

How many different tokens will your site have?

How much will each token be worth?

Refer to the following table to determine which rotary-switch position corresponds to a particular coin output.

Table 3. IDX Program Configuration

Coins	IDX Rotary Switch Position	Signal Line	Number of Output Pulses
Token 1	1	3	Determined by User
Token 2	2	3	Determined by User
Token 3	3	3	Determined by User
Token 4	4	3	Determined by User
\$1-Coin	5	2	1
Quarters	6	1	1

10.6.2 Programming the IDX to Accept \$1 Coins

The number of pulses is programmed by pressing the push-button the desired number of times prior to insertion of the sample/programming coins.

1. Set the rotary-switch to the position labeled number 5.
2. Press the button located immediately to the left of the switch once.
3. Drop six different dollar coins through the acceptor and verify that the light (LED) blinks after the last coin has been entered.
4. Move the rotary switch back to the position labeled '0'.

10.6.3 Programming the IDX to Accept Quarters

Follow the steps below to program the IDX to accept quarters.

1. Remove the front cover by pushing it in and up from the bottom right corner of the main body. (This is located near the phone number.)
2. Locate the rotary-switch and set it to the position labeled number 6.
3. Press the button located immediately to the left of the switch once.
4. Drop six different quarters through the acceptor and verify that the light (LED) blinks after the last quarter has been entered.
5. Move the rotary switch back to the position labeled '0'.

10.6.4 Site-Specific Tokens

Before you begin programming, be sure that you have six of each token you plan to program. You are responsible for supplying your own bi-metal tokens. Tokens are not available through Unitec.

The Coin Acceptor accepts tokens ranging in size from .984" – 1.125" in diameter. When programming site-specific tokens, it is important that you take into consideration the following items:

Tokens with a diameter of .984" are commonly used at nationwide arcade/pizza stores. The IDX coin acceptor will accept these tokens if your site-specific token is the same size.

Compare your token size with any local arcade tokens prior to programming the IDX coin acceptor to accept your site token.

The IDX acceptor can be programmed to accept up to four different tokens. The value for each token is programmed in the device profile based on how many pulses are sent on the token line.

To program the IDX to accept a single token, follow the instructions below.

1. Set the rotary-switch to position 1, 2, 3, or 4.
2. Press the button immediately to the left of the rotary-switch one or more times depending on the number of pulses you want that token to send.
3. Drop six sample tokens through the coin slot one at a time, and verify that the red light (LED) blinks several times after the last token has been entered.
4. Reset the rotary-switch to "0" and replace the front cover.

If more tokens are required, refer to Programming the IDX Acceptor to get the switch locations for that particular token, and then press the push-button the number of times that is equal to the number of pulses to be sent for that token.

10.6.5 Erasing IDX Programming

If you need to erase programming or start over, use the following procedure:

1. Remove the front cover from the IDX acceptor.
2. Set the rotary switch to the position that corresponds to the coin you wish to re-program or erase.
3. Depress the button located immediately to the right of the rotary switch only once.
4. Return the rotary switch to zero without passing any coins through the acceptor. This will erase the program that has been stored for that number.
5. Return the front cover to the IDX.

10.7 Coin Hopper(s) (Optional)

The Sentinel is can be equipped with up to 3 Suzo Mark II coin dispensers, which is embedded in a proprietary Unitec design. The dispenser is able to hold/dispense up to 2,400 quarter-sized coins. It is located inside the Sentinel case in the vault on the upper right.

10.7.1 Removing the Hopper Tray

To remove your hopper, slide the hopper tray forward. Filling the Hopper



Note: When filling the hopper, be sure to enter a “Cash Deposit” in the Cash Maintenance screens.

1. Open the right vault door of the Sentinel.
2. Slide the hopper tray out and remove the appropriate hopper.
3. Pour the replacement coins into the large opening at the top of the hopper assembly. Remember to direct the coins toward the inclined plane.
4. When the coin level is close to 600 - 1200 coins, begin to add coins by hand. Using this method, coins will tend to slide into the dispensing wheel more easily, which will reduce the possibility of clogs and jams.

10.7.2 Changing the Dispense Value

If you want your unit to dispense the dollar coin, the coin-hopper must be modified to accommodate the larger coin. The dispense value of the Sentinel device profile must also be changed to match the value of the dollar coin. The default value for this function is \$.25. See the device profiles section of the Sierra Management Application Operations Manual for information on programming the Sentinel to dispense dollar coins.

1. Gently lift the coin bucket from the hopper dispenser and set it aside. Be careful not to damage the sensor wire connected to the side of the coin bucket.
2. Separate the black hopper cube from the center of the metal body of the assembly by pressing in the round red locking tab while pushing the black hopper cube forward.
3. Slide the red locking clasp downward.

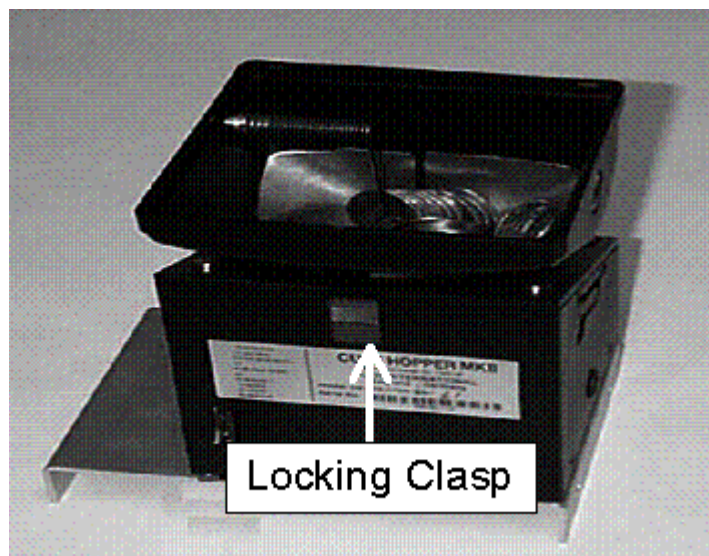

Figure 62. Hopper View - Removing the Hopper - Cube Top

- Slide the top piece of the black plastic hopper up and off to expose the dispensing wheel.

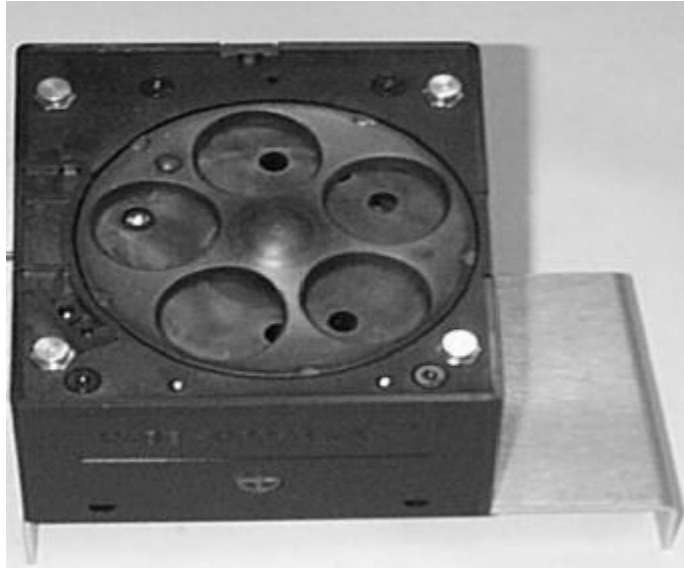

Figure 63. Hopper View - Top Removed

- Remove the dispensing wheel.

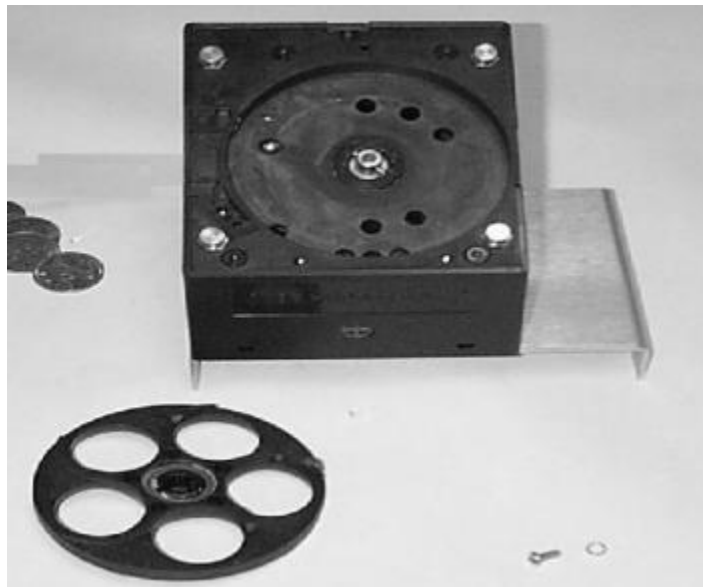

Figure 64. Dispensing Wheel Removed

- Remove the guide arm cover from the coin exit opening.

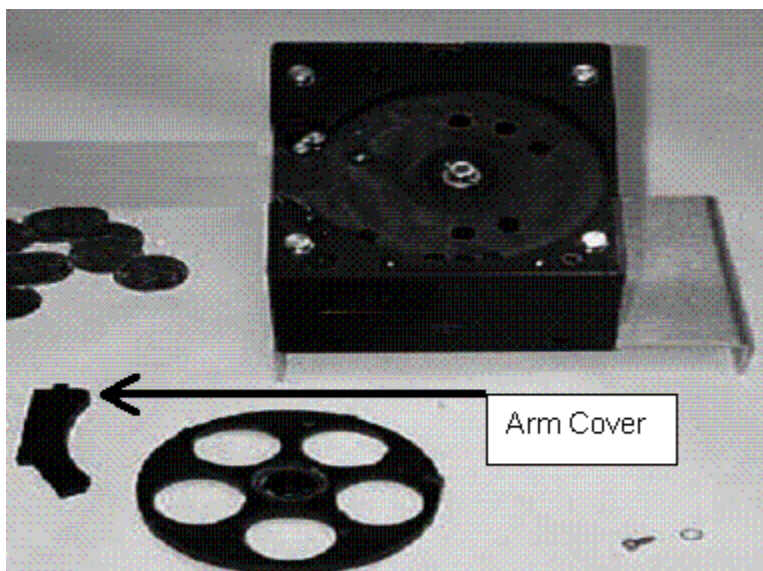

Figure 65. Guide Arm Cover Removed

7. Using a screwdriver, gently pry off the old hopper arm. Be very careful not to break the pins that hold the arm in place.
8. Place the new hopper arm into the slot exactly as the old one was.
9. Place the new hopper wheel into the plastic hopper exactly as the old one was.
10. Once the new guide arm and dispensing-wheel have been replaced, reinstall the coin guide arm cover.
11. Slide the black plastic top back onto the hopper-cube assembly. Securely latch it in place by locking the clasp.
12. Place the hopper-cube back onto the mounting bracket and snap the locking tab back into place.
13. Reattach the coin bucket by replacing the three screws you removed previously. Be sure that the coin exit opening of the hopper-cube is properly aligned with the exit chute of the metal housing.

10.8 Proximity Sensor

The Sentinel uses an ultrasonic proximity sensor, mounted on the lower right-hand corner of the interior side of the door, to detect the presence of a customer's vehicle. The distance at which the proximity sensor senses a vehicle can be adjusted by turning the small Phillips-head screw located on the back of the proximity sensor.

To adjust the proximity sensor:

1. Place a flat surfaced object approximately 12" x 12" in front of the proximity sensor at the MAXIMUM distance you wish the proximity sensor to detect approaching vehicles (at least 36").
2. Briefly press the TEACH button. The yellow LED will flash off then on again after 2 seconds.
3. Place the flat object in front of the proximity sensor at the MINIMUM distance you wish the proximity sensor to detect approaching vehicles (at least 6").
4. Briefly press the TEACH button. The yellow LED will flash off then flash on 5 times.
5. The settings are now saved in the proximity sensor.

10.9 Thermal Printer

The Sentinel is equipped with the Hecon thermal printer. The Hecon printer uses paper rolls 2.28" to 2.36" wide by up to 400'. The thermal printer is capable of printing graphics and barcodes, as well as system reports.



Figure 66. Hecon Printer

The following sections contain information and procedures important for peak operating performance.

- Replacing the Printer Paper
- Cleaning the Head
- Clearing a Paper Jam
- Manually Printing a Self-Test

10.9.1 Replacing the Printer Paper

Replace printer paper when you see a red mark running down the side of the receipt or the unit is reporting Paper low.

1. Insert the new paper roll on the paper carriage at the bottom of the printer. The paper roll should be oriented such that the end of the paper is at the top of the roll. The paper will automatically feed into the printer when the power is on.

10.9.2 Clearing a Paper Jam

Follow the steps below to clear a paper jam.

1. Open the Sentinel door.
2. Locate the blue locking arms on the sides of the printer assembly, pull them out and remove the main printer assembly by lifting it up and out.
3. Locate and remove the paper jam.
4. Once the jam has been dislodged, replace the main printer assembly and relock the blue locking arms.
5. Feed the paper into the slot marked "Paper Insert."
6. Test the printer.

10.9.3 Manually Printing a Self Test

If you ever question whether the printer is functioning properly, you may have the system print a self-test page. This printout will cycle through each available character. If the test prints completely and the printing is legible, this is considered a passed result.

To test the printer through the software, open the Sentinel door and login to the Maintenance Mode. Press the Test Hardware button then Test Printer. The printer will print a self test.

Appendix A : Talaris Dual Cassette Bill Dispenser Maintenance

The dual cassette bill dispenser allows you to dispense cash from the Sentinel as change. It dispenses \$1 and \$5 bills from two cassettes. The following figure shows the bill dispenser with the primary components labeled.

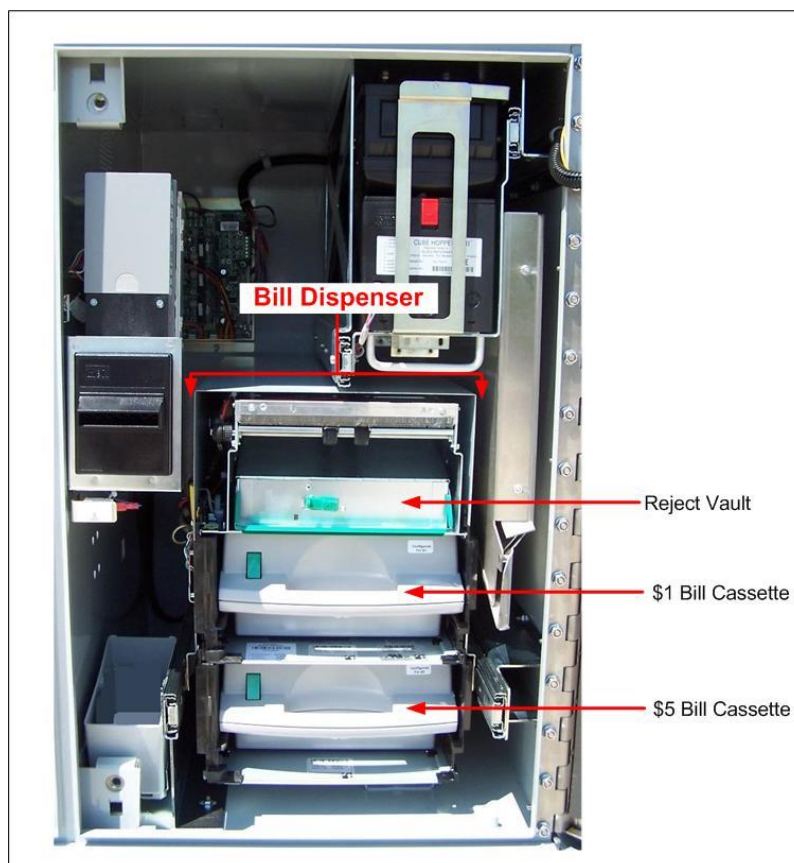

Figure 67. Bill Dispenser Parts

Removing Bill Cassettes

IMPORTANT: Before removing the cassette it must be unlocked on the Cash maintenance screens.

The cassettes can be removed in any order. All cassettes do not have to be released and closed to remove one cassette.

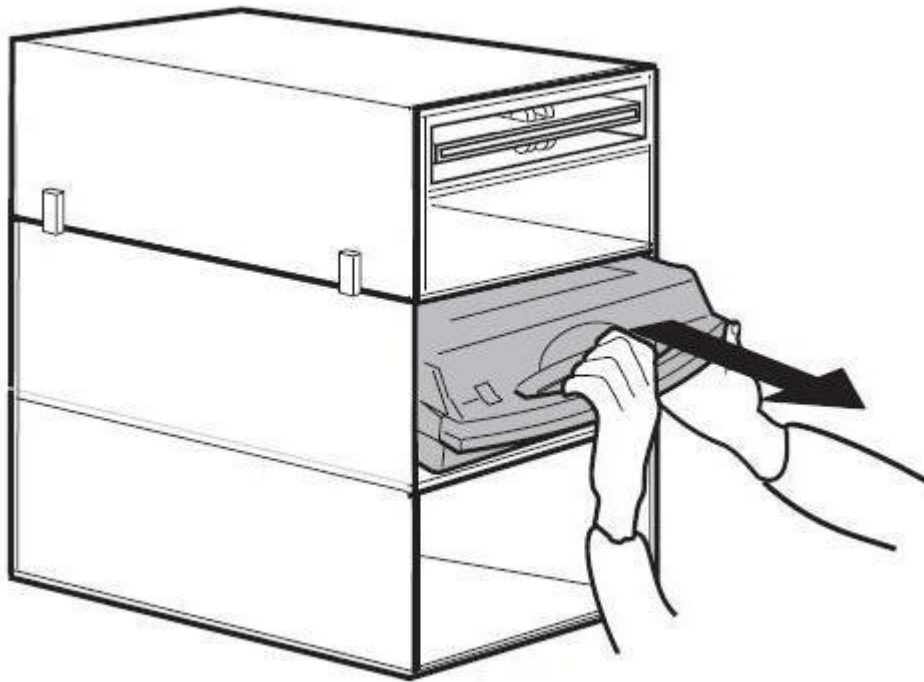

Figure 68. Remove the Bill Cassette

1. Use the handle and support the cassette underneath. Slide the cassette straight out.

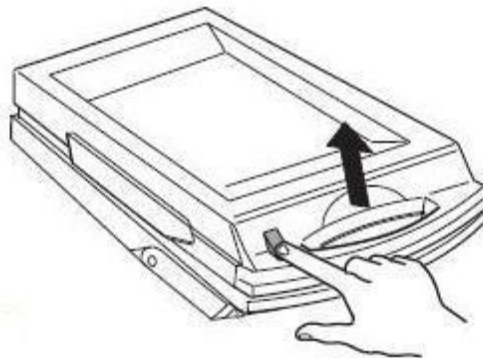

Figure 69. Unlock Cassette

2. Open the cassette by simultaneously pressing the green button and lifting the lid. Pay special attention only to load bills of the correct denomination into the cassettes.

Preparing and Loading Bills

The number of rejects depends directly on the loading procedure and the quality of the bills. Without preparation, feeding problems may occur, such as higher reject rate or jam in the transport path. The following procedures are recommended to aid easier bill feeding from cassettes.

If you are using new, unused bills:

- Remove the band around each bundle of bills.
- Separate the bills from each other by:
 - Striking the bundle hard against the edge of a table or similar object.
 - Flipping through each bundle of bills in both directions at both ends.

If you are using used bills:

- The bills must not be limp and should be reasonably clean.
- Remove the band around each bundle of bills.
- Remove foreign objects, e.g., pins, paper clips, crumbs etc.
- Remove torn or very worn bills.
- Straighten any folded bills.

Do not use the following types of bills:

- Sticky surfaces
- Repaired with tape
- Torn edges
- Having holes or missing sections
- Crumpled
- Dog-eared, with a folded edge exceeding 5 mm
- Limp or moist
- Combination of new and used bills in the same cassette

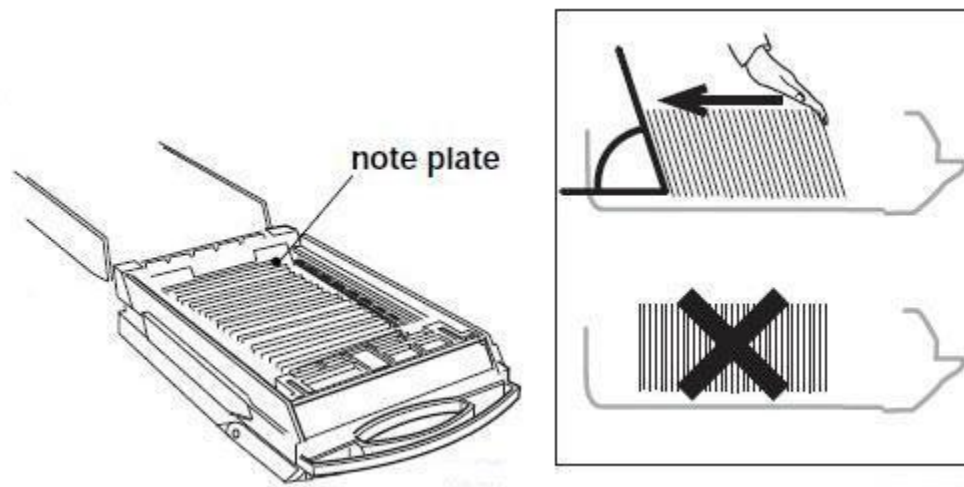

Figure 70. Load Bills into Cassette

1. Place the prepared bills into the back of the cassette closest to the hinge. The bills should lean slightly but evenly onto the metal bill plate in the back of the cassette. Pay special attention to load only bills of the correct denomination into the cassettes.
2. Level the bill pile slightly by hand. Single bills must not protrude from the bundle.

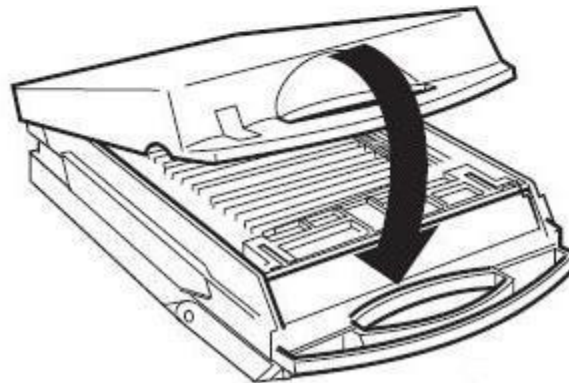
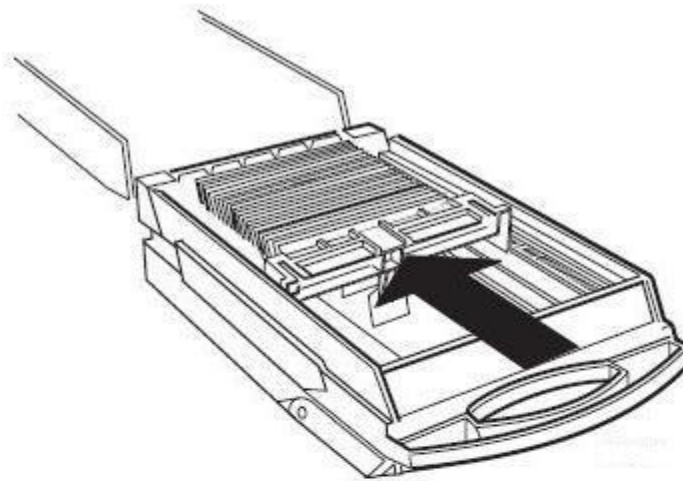

Figure 71. Tension Plate and Lid

3. Move the tension plate towards the bills close enough to hold the bills into the correct position when closing the lid and inserting the cassette into the bill dispenser.
4. Close the cassette lid and press carefully to fully shut the cassette. The green button will pop out when the cassette is fully closed.

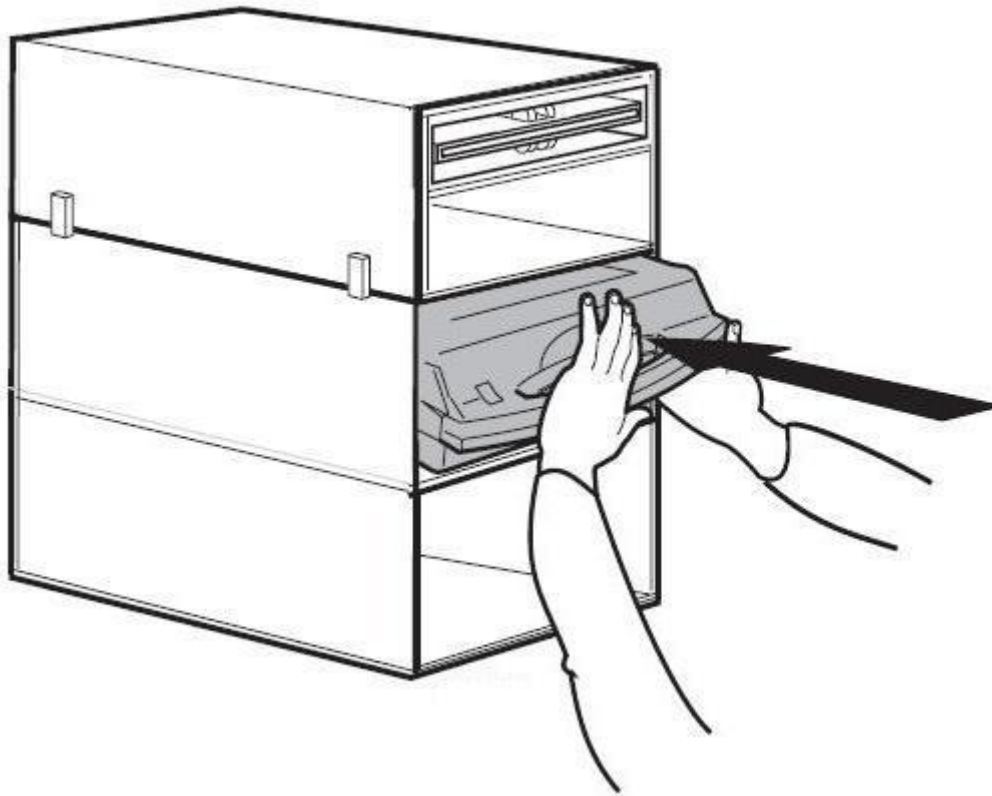

Figure 72. Insert Cassette

5. Using the handle and supporting the cassette underneath, slide the cassette straight into the machine, making sure the \$1 cassette is loaded into the top slot and the \$5 cassette is loaded into the bottom slot.

The cassettes are now ready to be locked using the Cash maintenance screen.

Emptying the Reject Vault

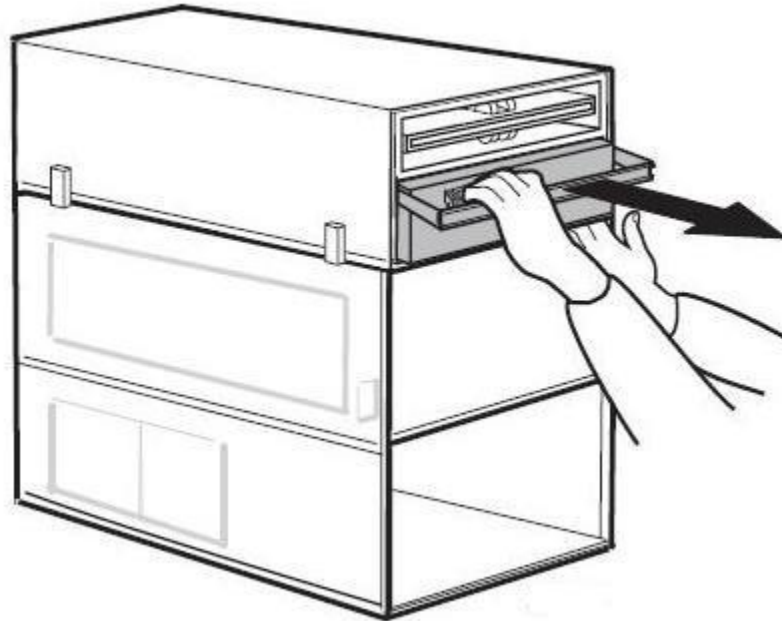

Figure 73. Remove Reject Vault

The Reject Vault has a color indicator window located on the front of the vault by the release switch. The color indicator shows a green window when the Reject Vault is opened for collection and when it is ready for use. The color indicator shows a red window when the Reject Vault is inserted into the dispenser and until it is opened for collection outside the machine.

1. Use the handle and support the vault underneath. Slide the vault straight out.

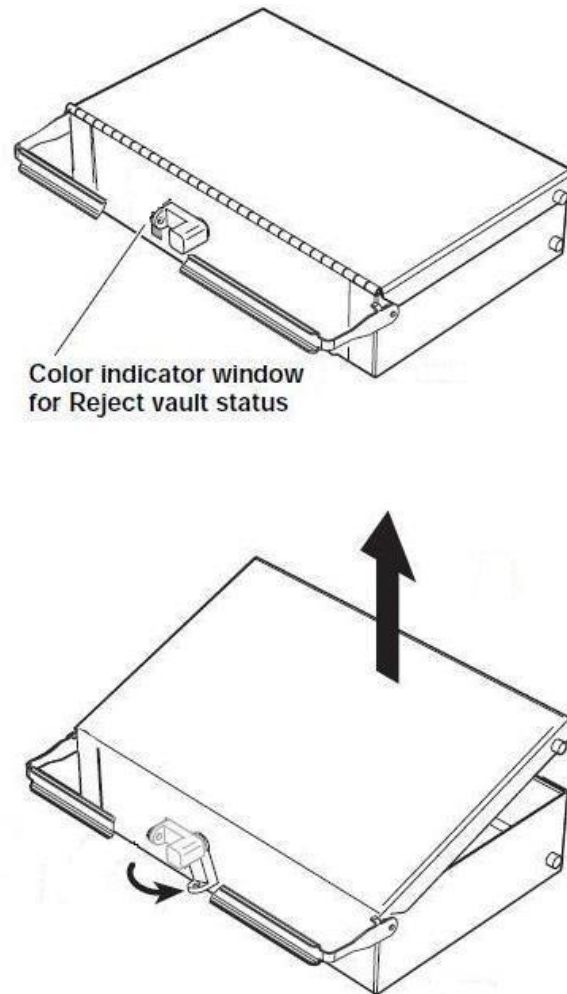

Figure 74. Unlock and Open Reject Vault

2. The bill dispenser's reject vault is locked when it is removed from the dispenser. To open the vault, turn the small switch on the front counterclockwise and lift the lid. Release the handle.
3. Remove the rejected bills.
4. Turn the little switch on the front counterclockwise about a half turn and close the lid. The color indicator should show a green window. The vault is then ready for use in the dispenser again.

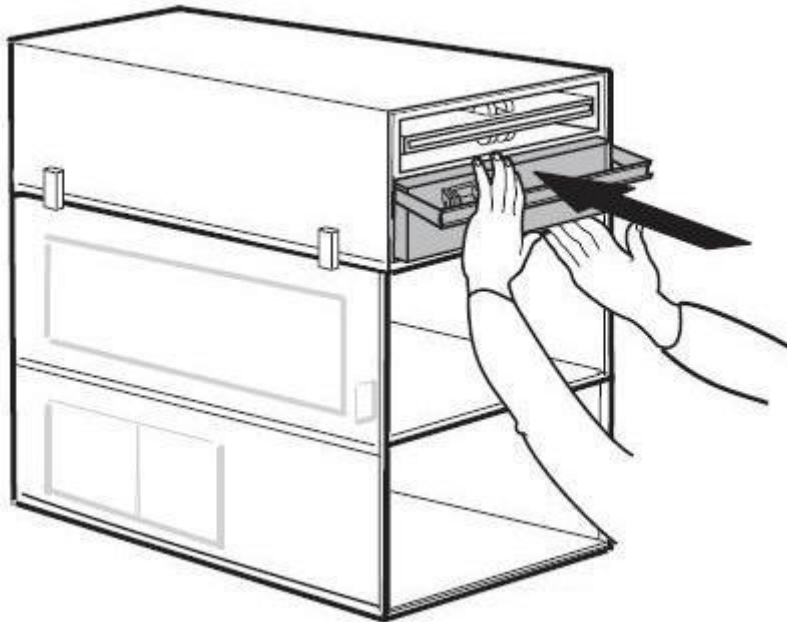

Figure 75. Insert Reject Vault

5. Using the handle and supporting the vault underneath, slide the vault straight into the machine. Make sure the vault is fully inserted. The lip of the vault will sit behind the lip of the bill dispenser with the handle resting on the edge. The lid of the vault should be raised in the back to accept the rejected bills.

The vault is now open and ready to be used.

Clearing Bill Dispenser Jams

If there is a bill jam, you will need to remove the jammed bill. After removing the jammed bill, verify the bill dispenser is functioning properly using the Test Devices function of the Maintenance Mode at the Sentinel.

Removing a Jammed Bill from the Bill Feed Path

Important! Always switch the **power off** before clearing jams.

1. Remove Bill Cassettes.
2. Pull the bill dispenser from the unit to the end of the track to access the back of the dispenser.

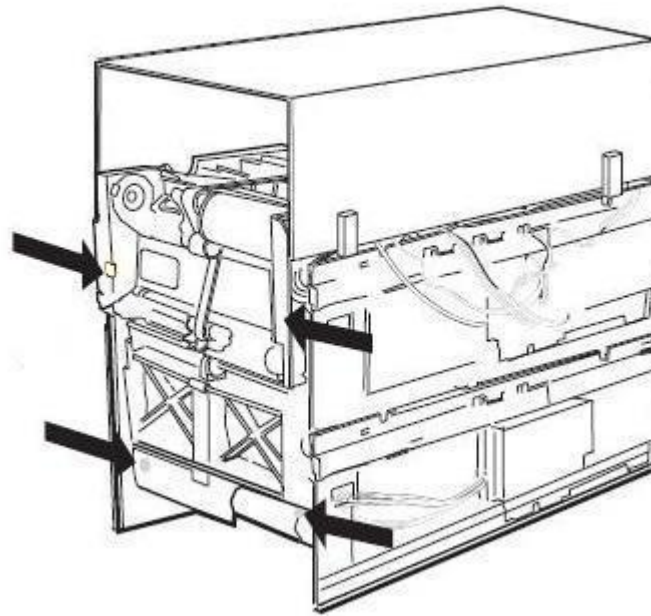

Figure 76. Release Back Flaps

3. Press the yellow snap fits to release the back flaps.

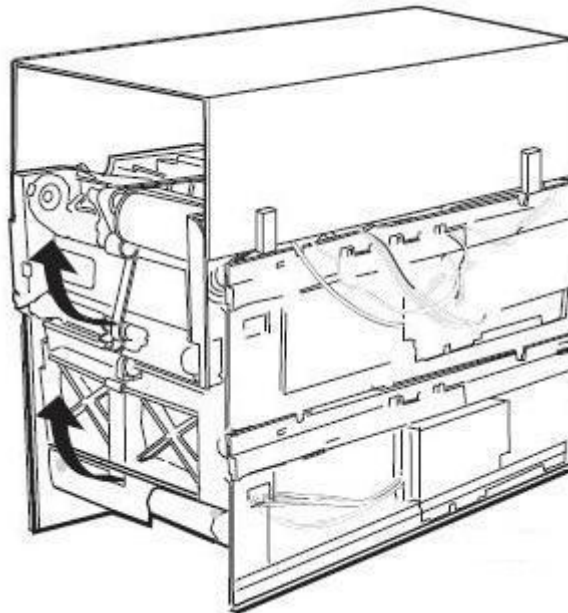

Figure 77. Clear the Back Flaps

4. Lift the flaps up and clear the bill path of bills.
5. Close the lids carefully.

Removing a Jammed Bill from Bill Transport Path

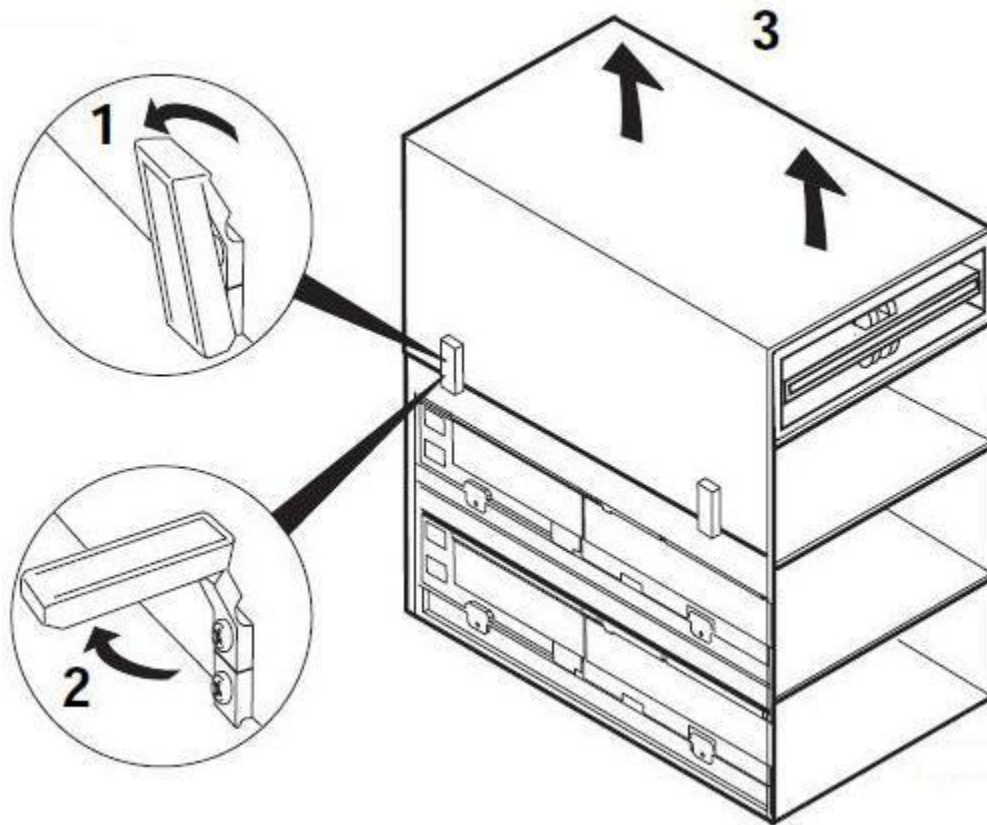

Figure 78. Unlock the Top Lid

1. Release the latches on the top lid of the bill dispenser by pulling out the top of the yellow latches and then lifting them up to unlatch the lid.
2. Open and remove the top lid of the bill dispenser.

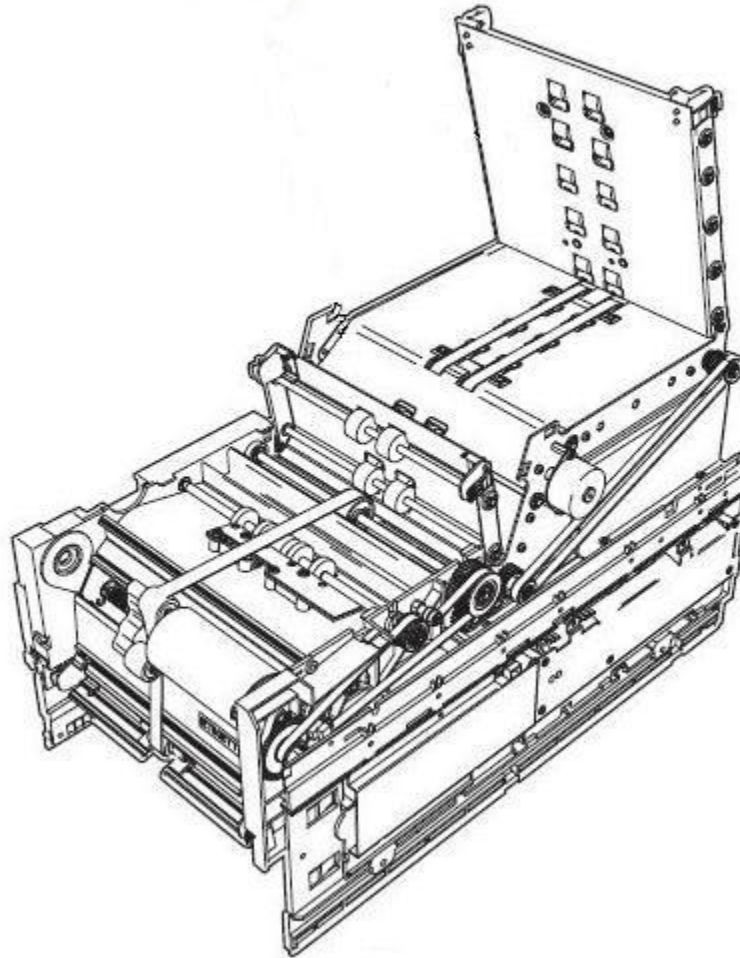

Figure 79. Clear the Bill Path

3. Open both bill transport flaps by releasing the yellow snap fits at each outer side and folding the lids out.
4. Remove all jammed bills.
5. Close the Bill Transport flaps by pressing each outer end back in its locked position. Be careful not to damage the snap fits.
6. Mount the top lid of the dispenser and close the latches.